

# dapol

  
Gauge

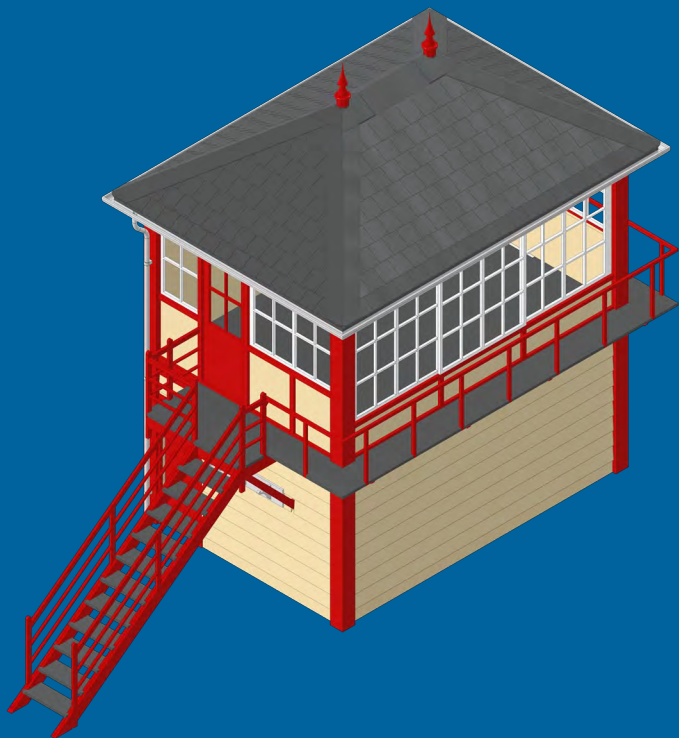

7B-001-002

Midland Railway Signal Box

Based on Ais Gill, Settle-Carlisle Line

  
TRADE MARK  
GENESIS

# Read Before Building

**Estimated Build Time:**

**10-12 hours**

This is a very complex kit, we strongly recommend taking your time building it. It is also very important to keep a clean work area as the card is permeable and can stain very easily.

We recommend using a standard PVA glue slightly diluted with water. We do not recommend any fast drying glues, as they can dry too quickly, making any small positional adjustments difficult. It's best to apply the glue using a small paintbrush or cardboard offcut.

Parts cannot be bought individually. Spare or replacement frets can be bought £10 each for large frets and £7 each for small frets by contacting [sales@dapol.co.uk](mailto:sales@dapol.co.uk)

Printed instructions are available free of charge by contacting [sales@dapol.co.uk](mailto:sales@dapol.co.uk)

But most of all. Enjoy.

# Checklist

- China White 5
  - A1
  - B2
- China White 6
  - C1
  - D1
- China White Thin 2
  - Bottom planks for A and B
- China White Thin 3
  - Bottom planks for C and D
- Clear 2
  - F1
  - F2 (x2)
  - F3
  - F4
  - F5
  - F6
  - F7
  - F9
- Scarlet 5
  - A3
  - A4 (x2)
  - F7
  - F8
- Scarlet 6
  - B3
  - B4
  - B5
  - E3 (x4)
  - E4 (x3)
  - E5
  - E6
  - E7
- Scarlet 7
  - C3
  - C4 (x2)
  - G8 (x2)
  - G9 (x2)
  - F11
  - F12
  - F13
  - F14
- Scarlet 8
  - D3
  - D4
  - D5
  - E8
  - E9 (x2)
- Slate 7
  - E1
  - E2
  - E10 (x11)
- Slate 8
  - G5 (x2)
  - G6 (x2)
- Slate 9
  - G3
  - G4 (x2)
- Slate 10
  - G4
  - G12
- Slate Thin 4 (x2)
  - Tiles
- Slate Thin 5
  - G11 (x4)
- White 8
  - A2
  - B2
  - C2
  - D2
- White 9
  - E1
  - E2 (x2)
  - E3
  - E4
  - E5
  - E6
  - E9 (x2)

1

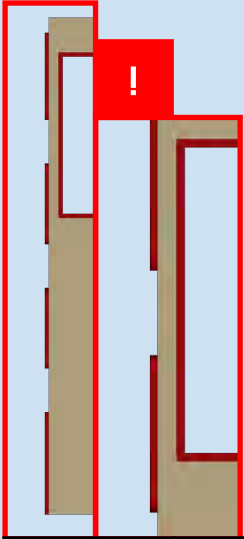

A1 & A3

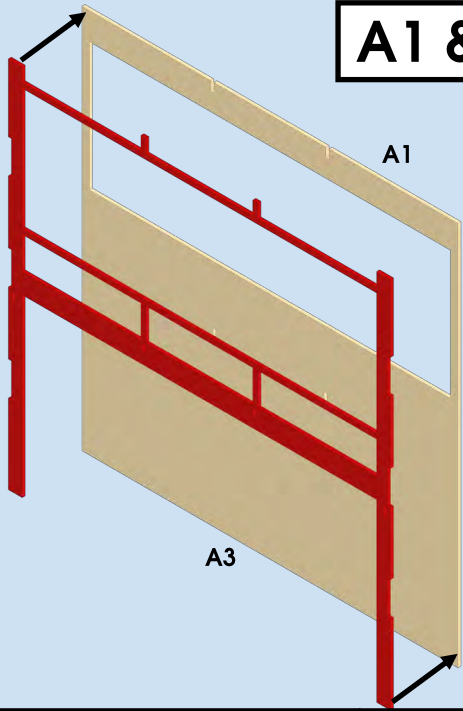

2

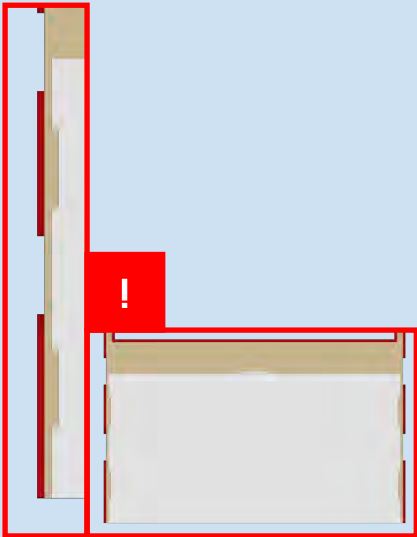

A & A2

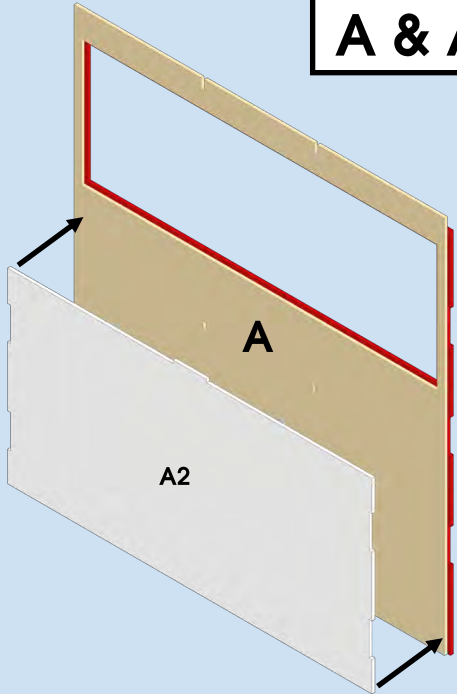

3

A & F2 (frame & glazing)(X2)

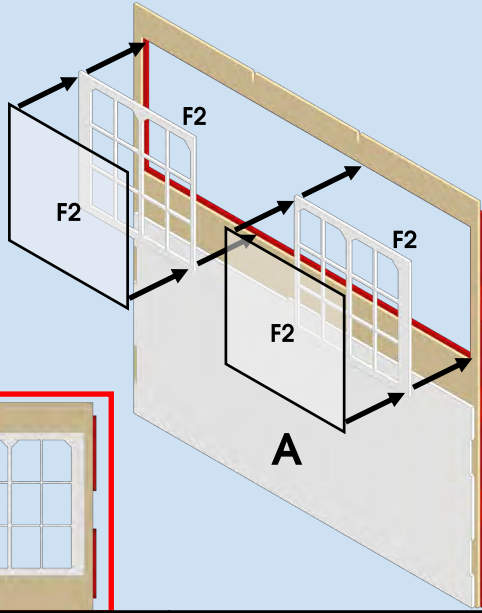

!

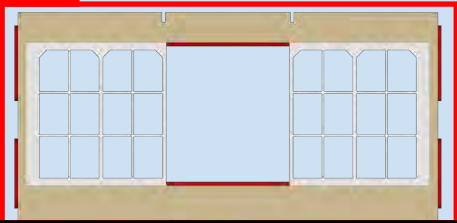

4

A & F1 (frame & glazing)

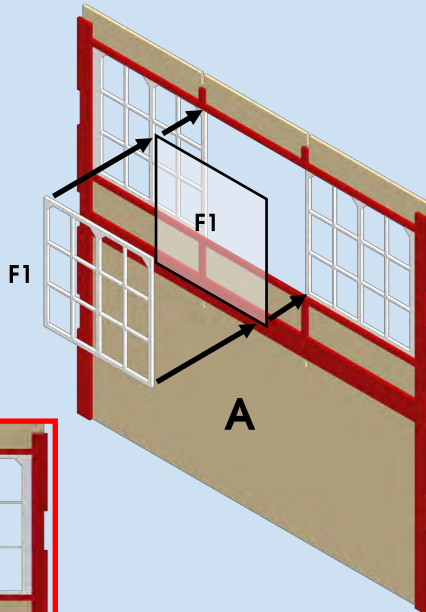

!

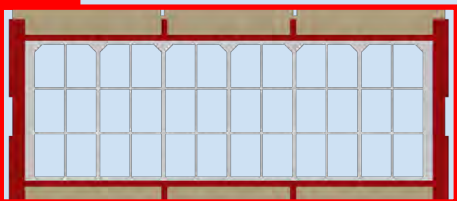

**5**

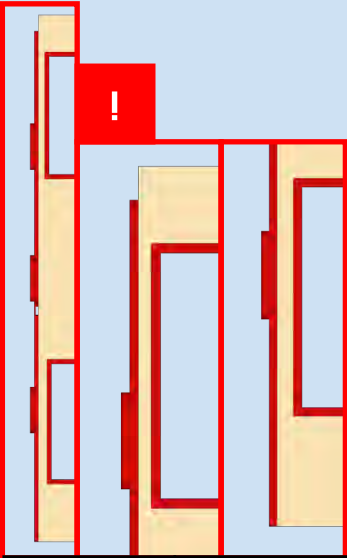

**B1 & B3**

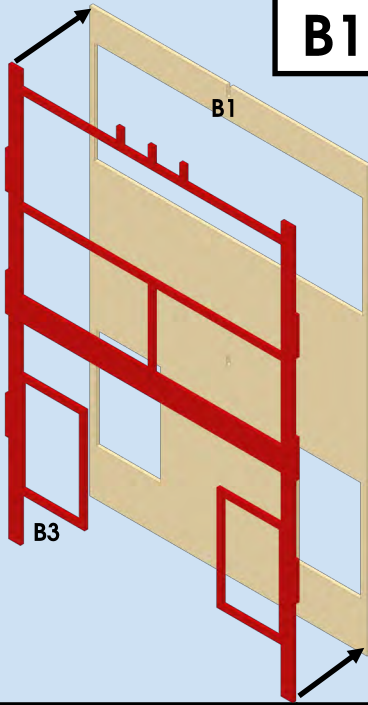

**6**

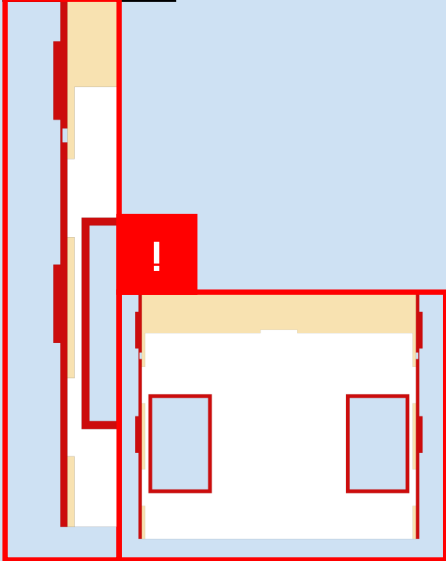

**B & B2**

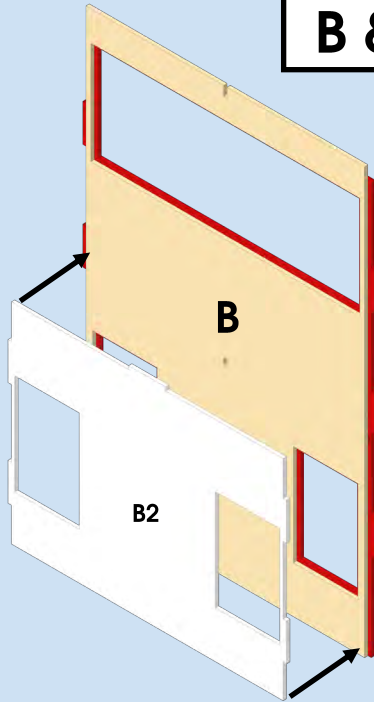

7

**B & F9** (frame & glazing) (x2)

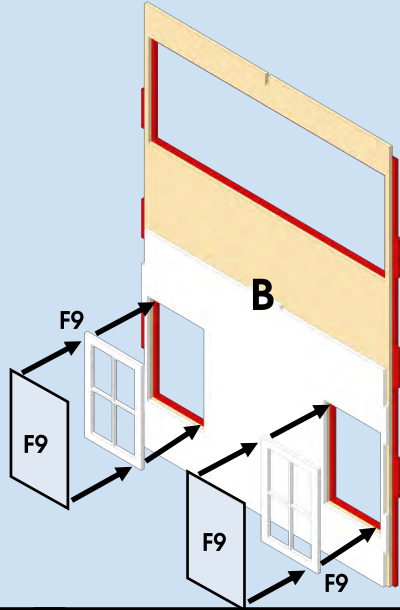
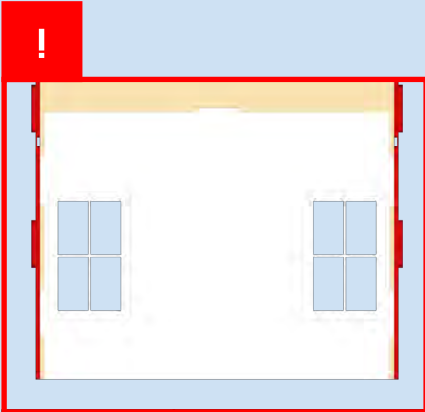

8

**B & F3** (frame & glazing)

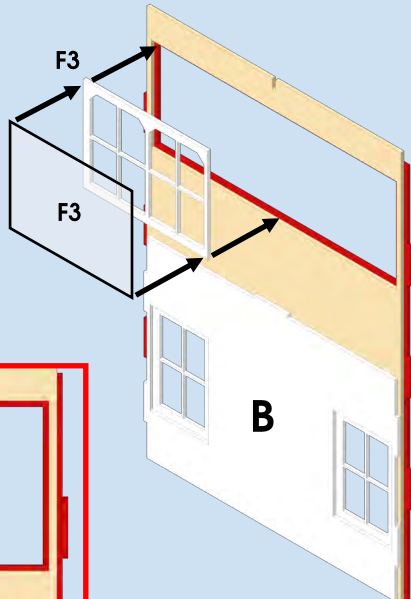
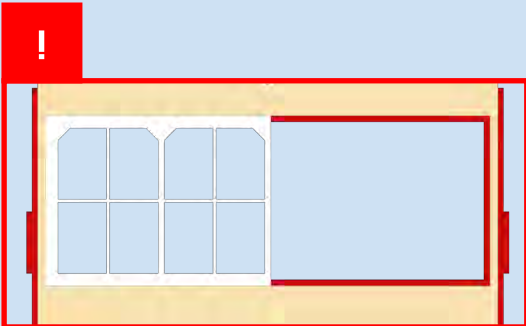

9

B & G4 (frame & glazing)

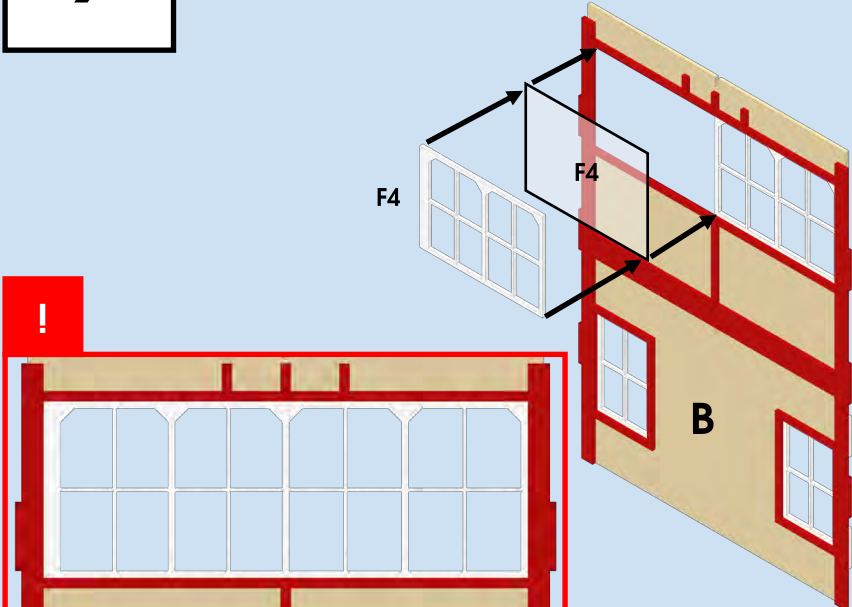

10

C1 & C3

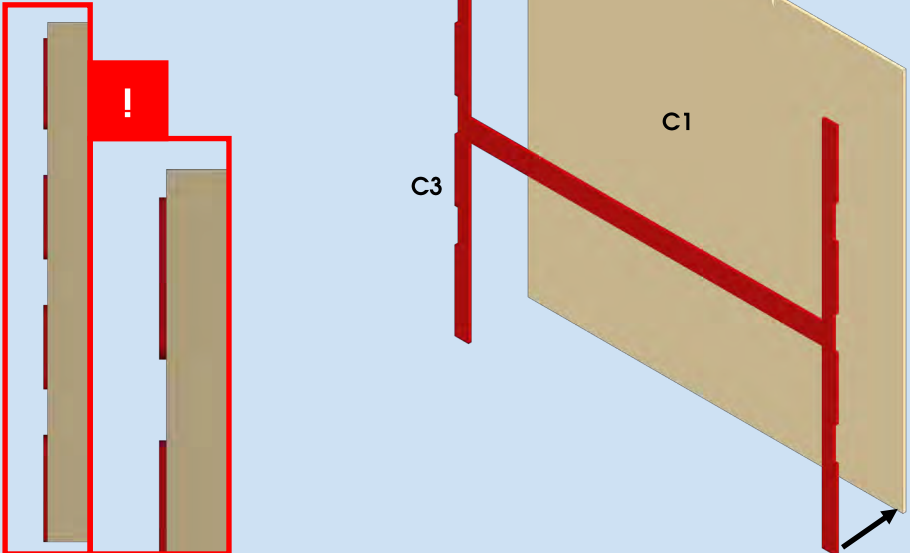



11

C & C2

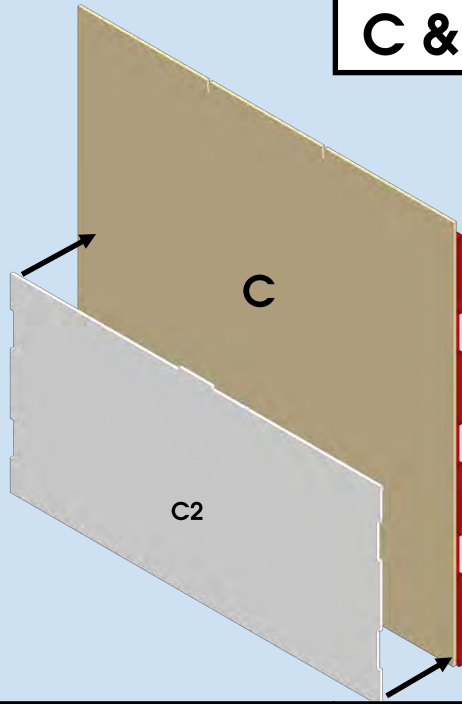
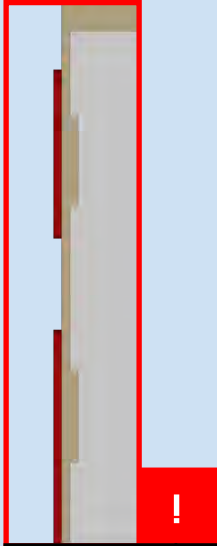

12

D1 & D3

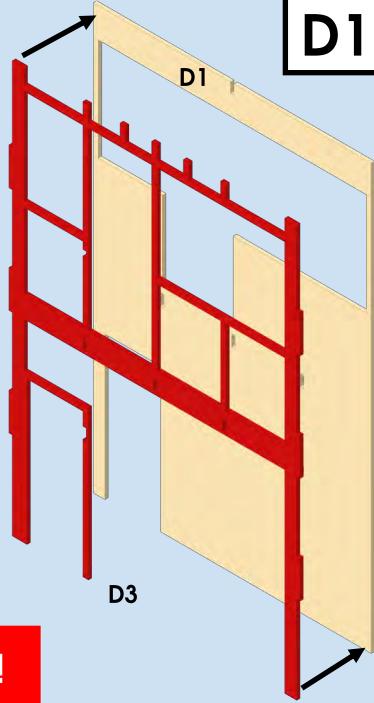
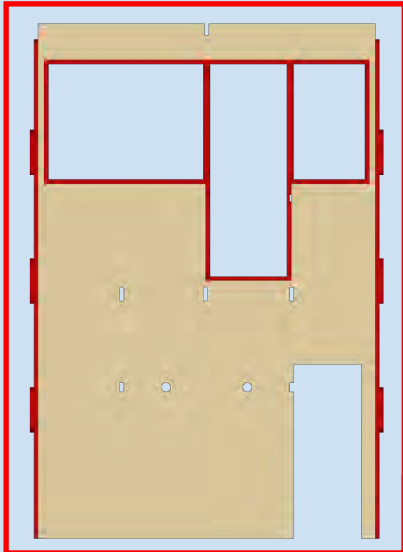

13

D & D2

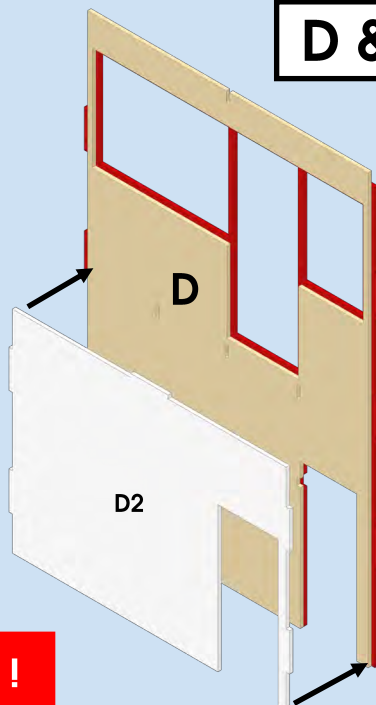

14

D, F7 (door & glazing) & F8

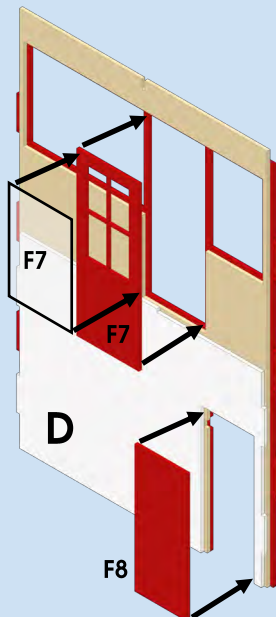
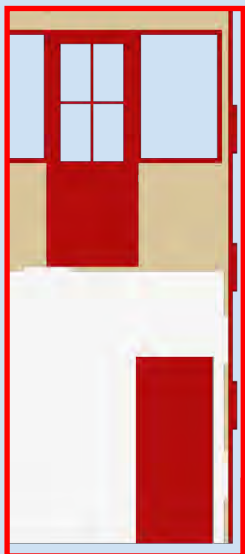

15

D & F6 (frame & glazing)

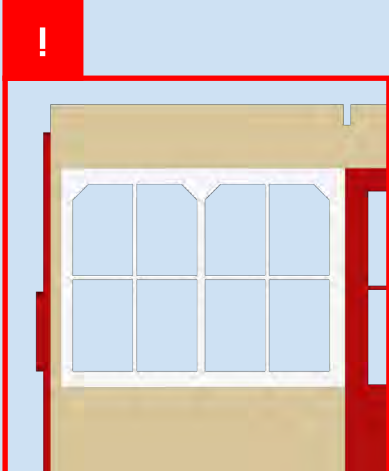
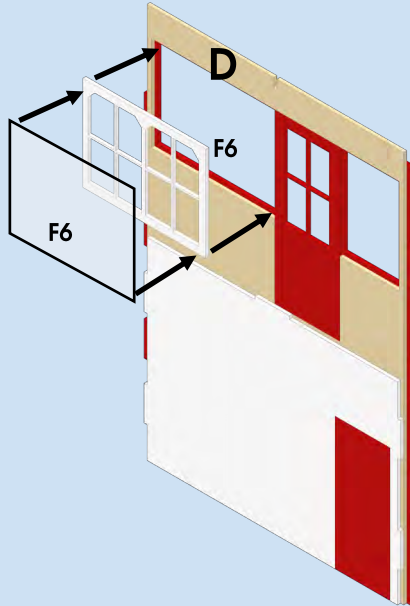

16

A & F5 (frame & glazing)

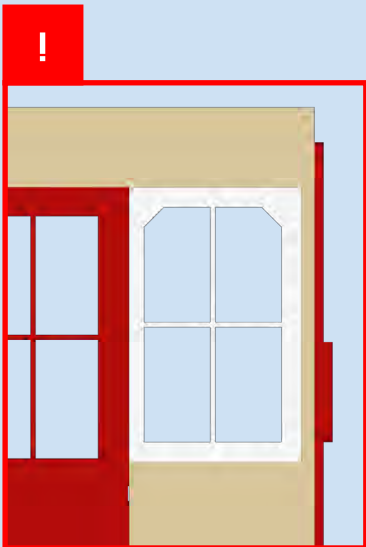
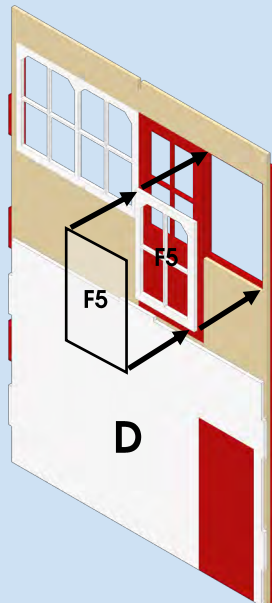

17

A & B

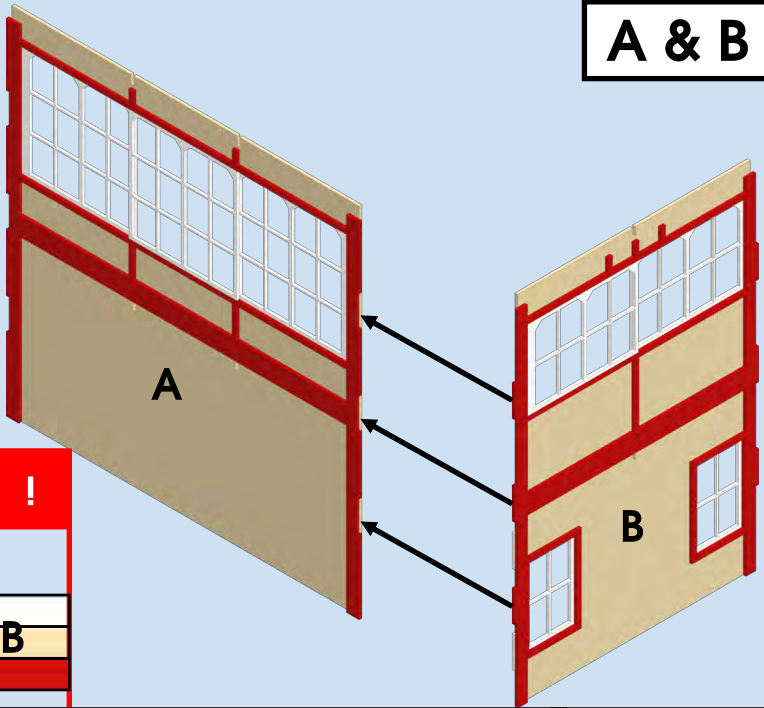

18

AB & C

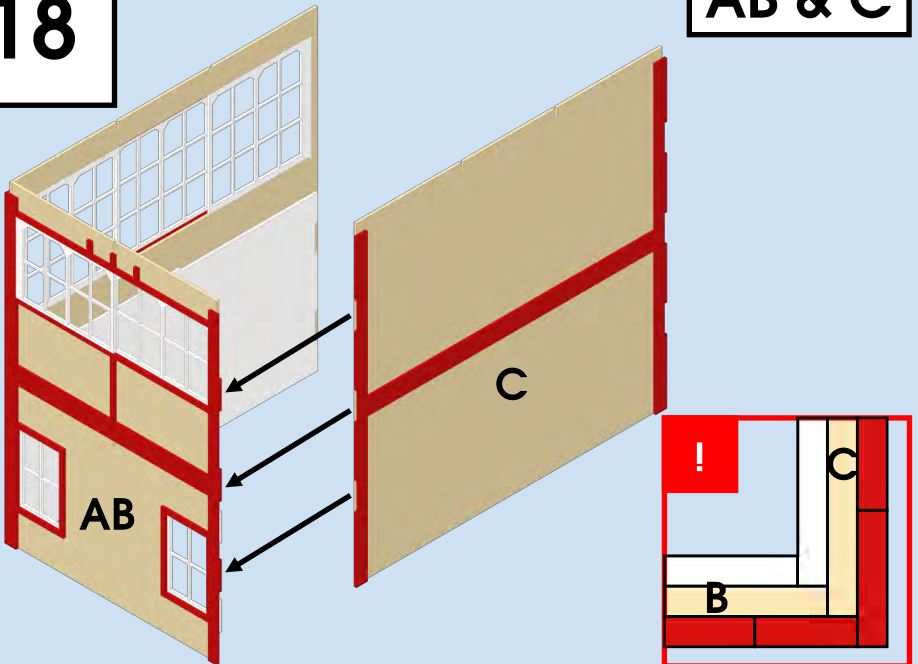

19

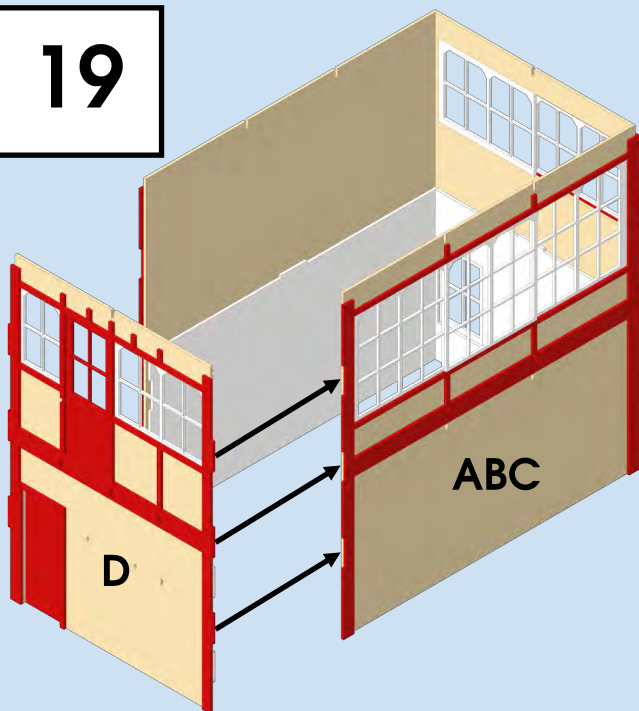

ABC & D

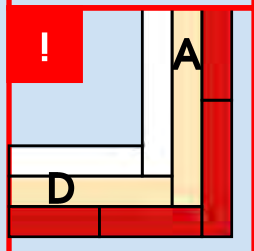
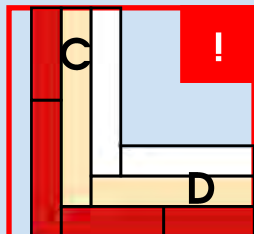

20

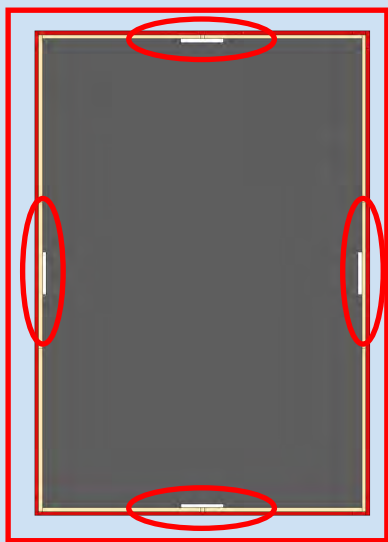

E1

E1

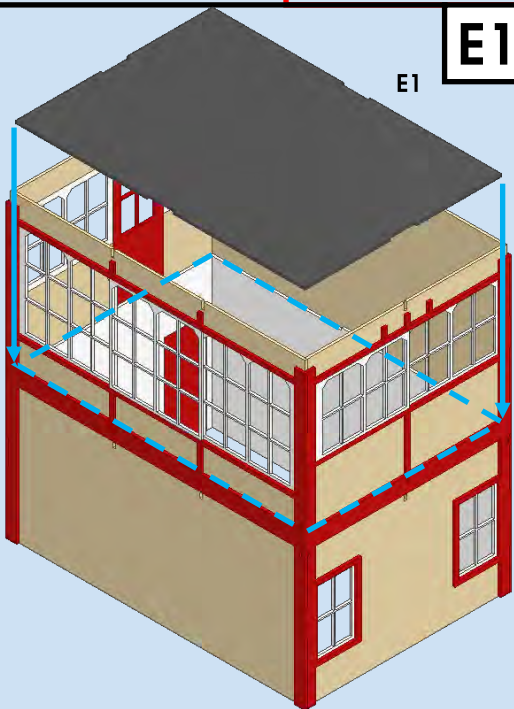

**21**

**A4(x2)**

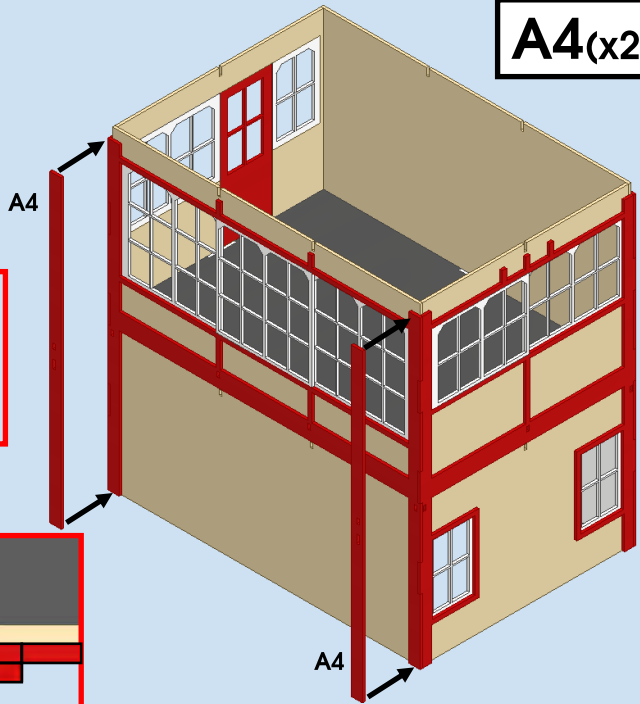
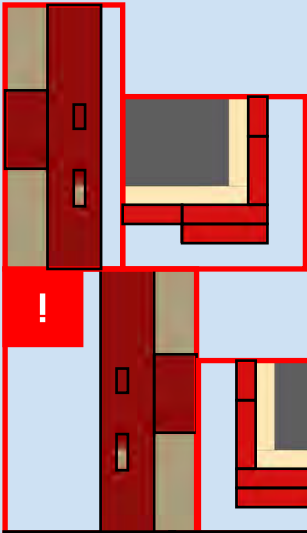

**22**

**C4(x2)**

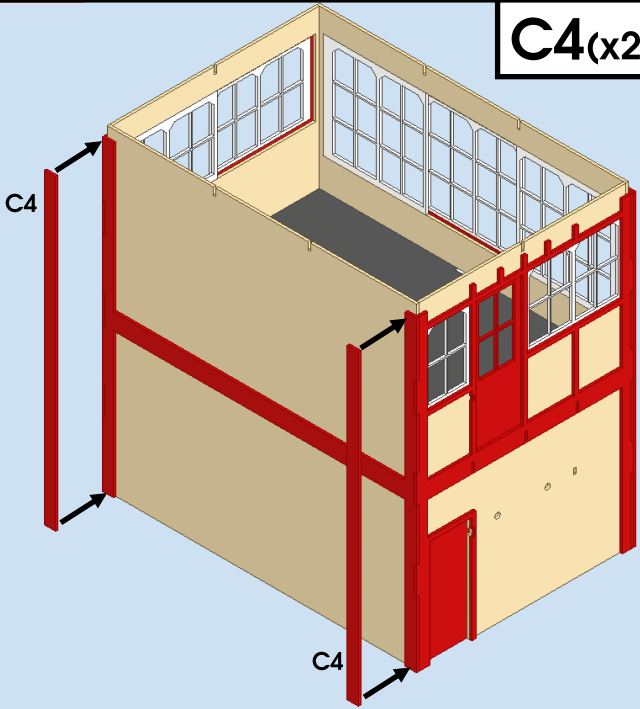
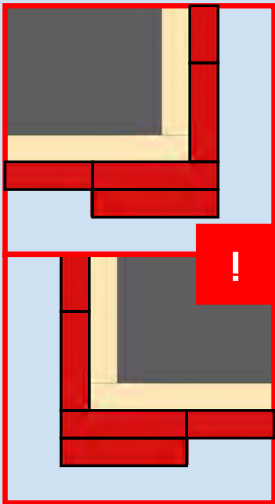

23

B4 & B5

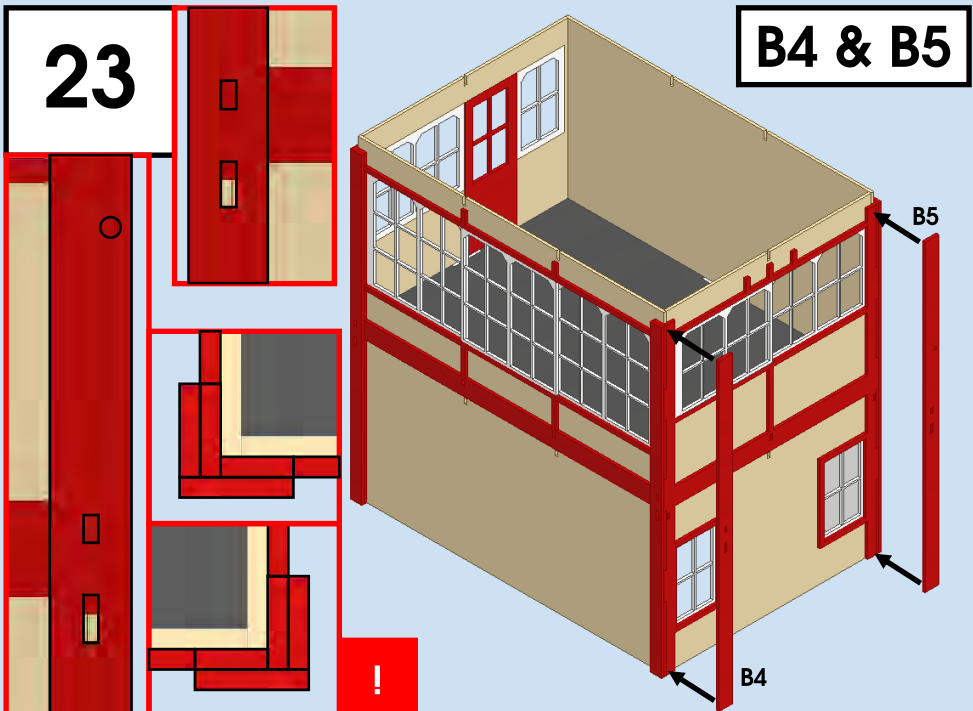

24

D4 & D5

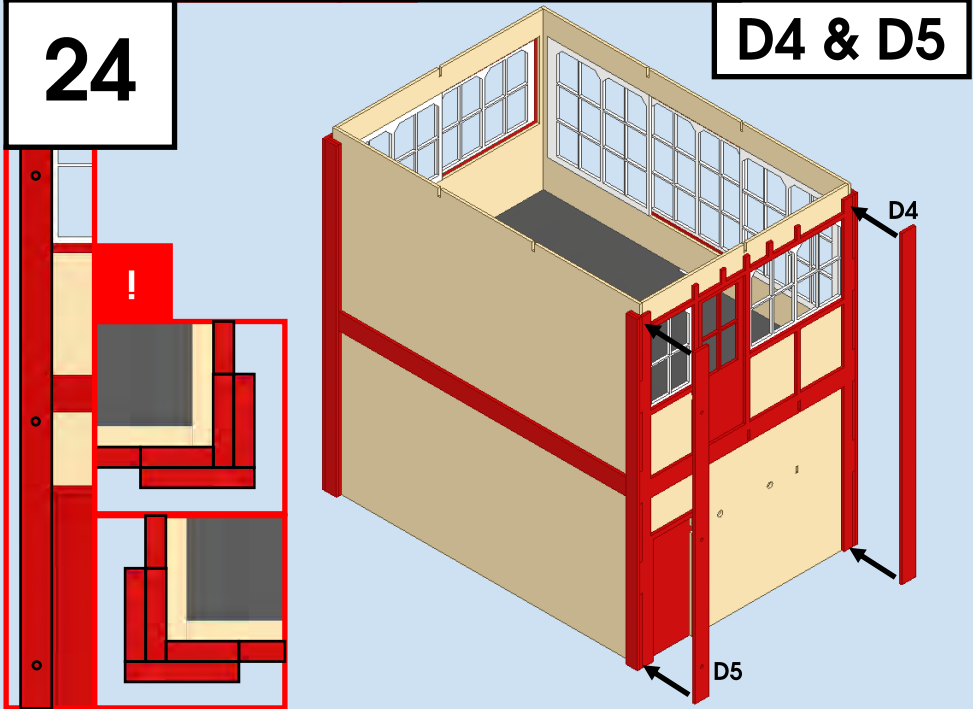

25

E3(x4) & E4(x3)

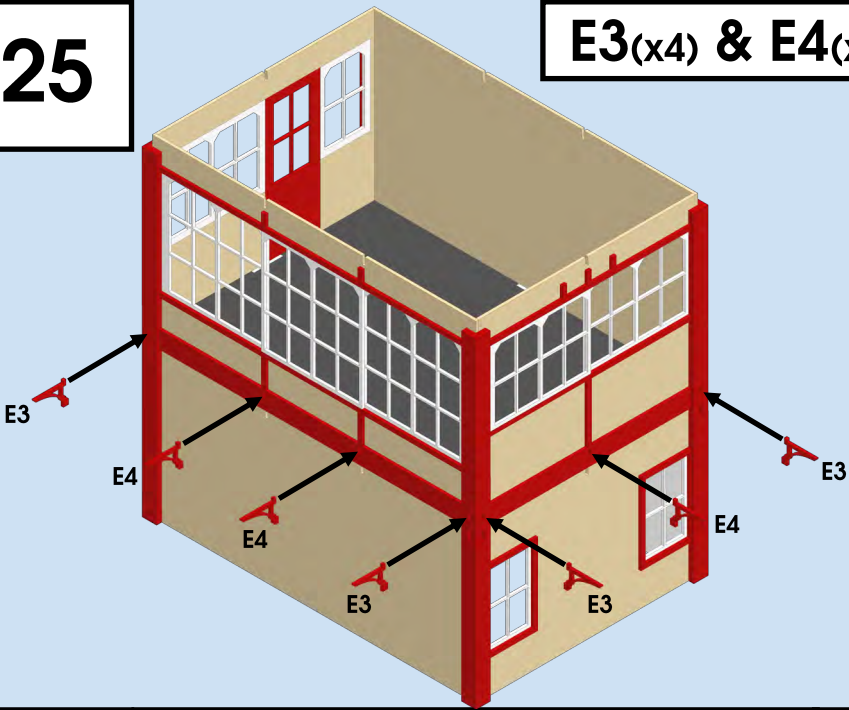

26

E2

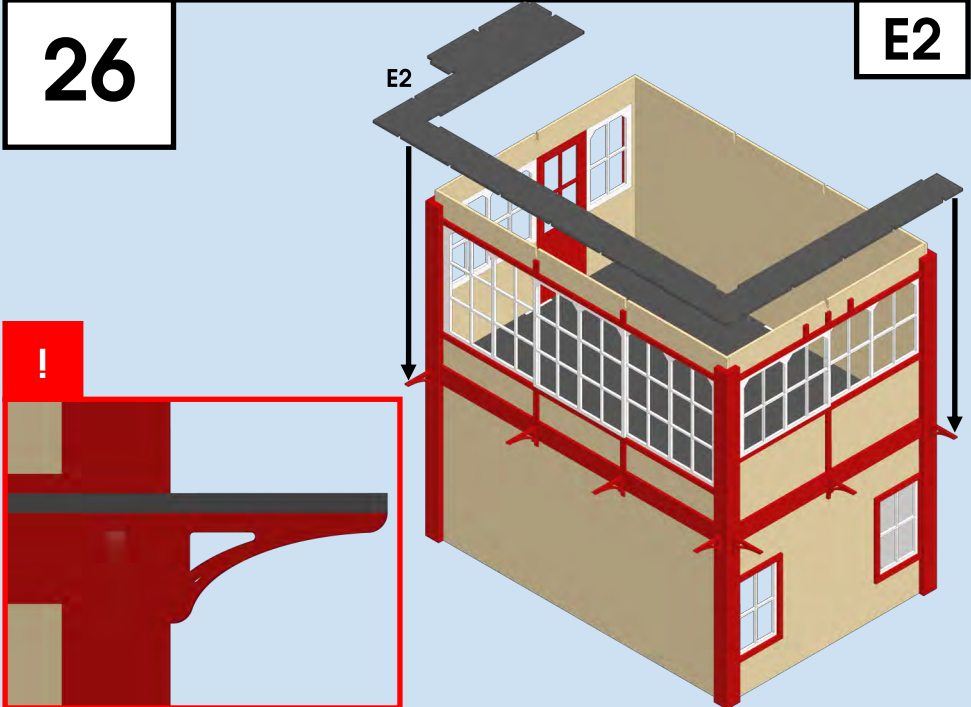



27

E5

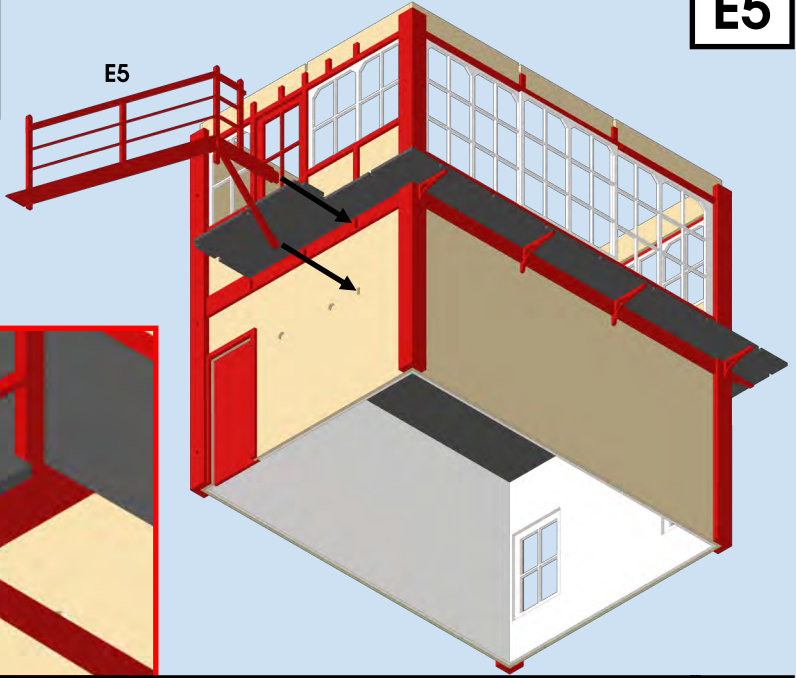

28

E7

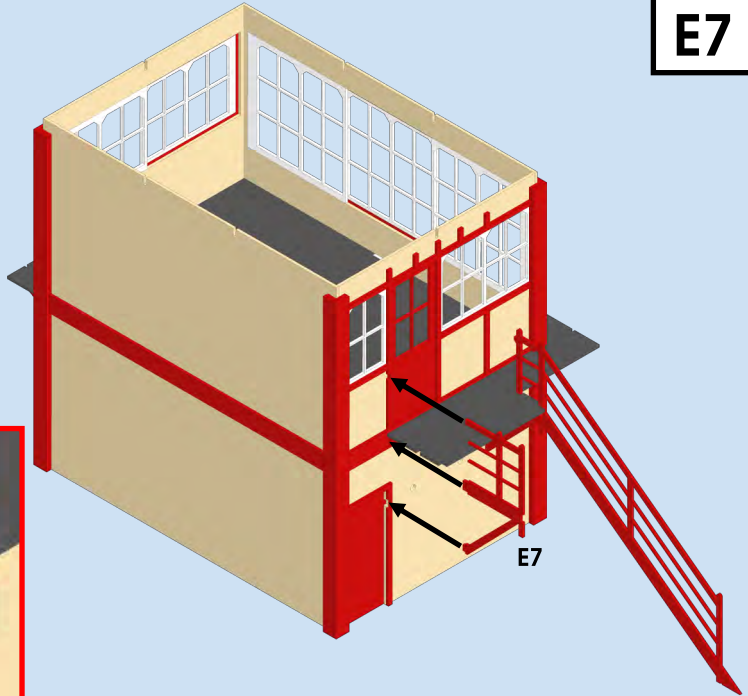

29

E6

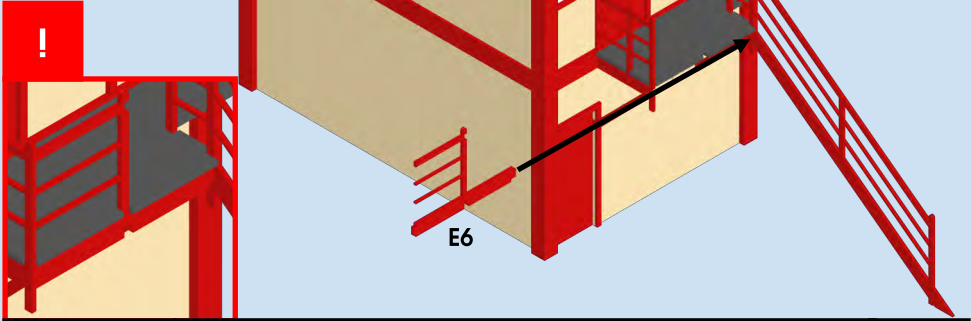

30

E8

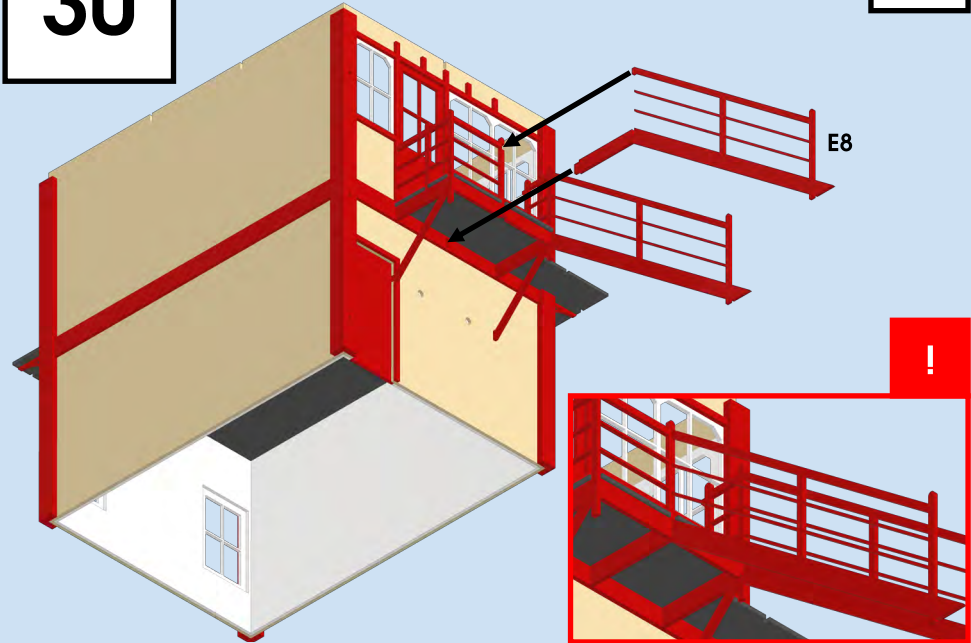

**31**

**E9**

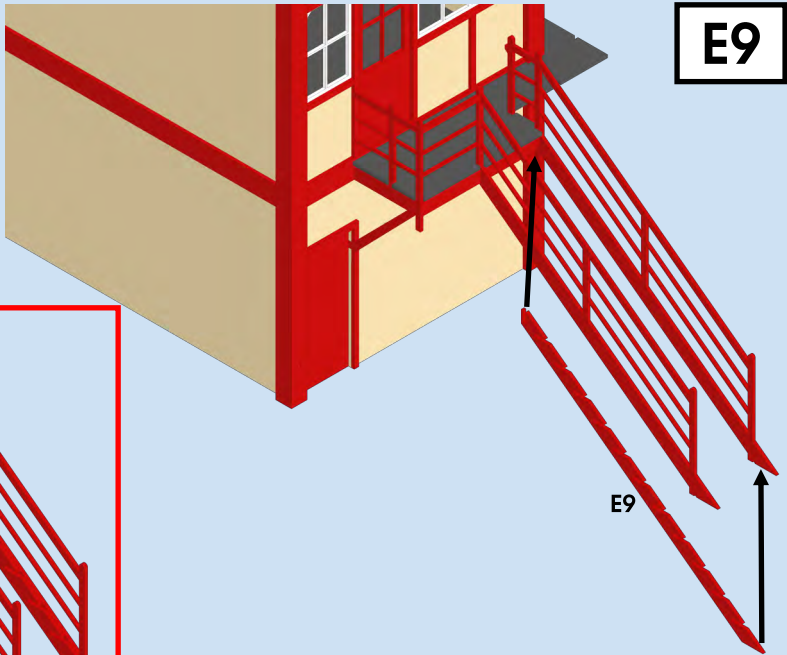

**32**

**E9**

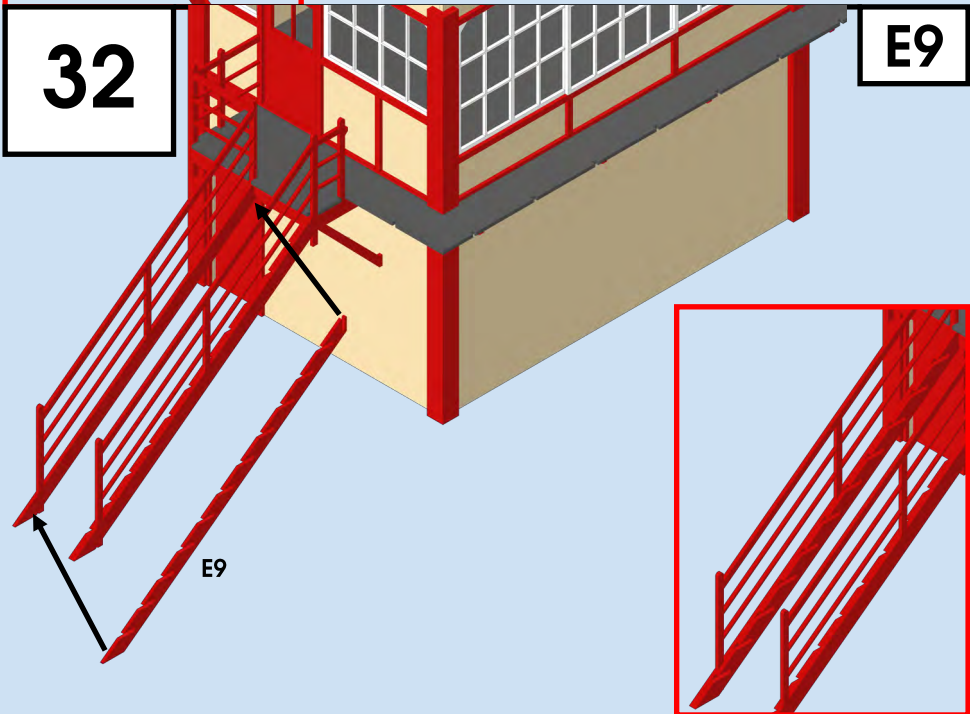

33

E10

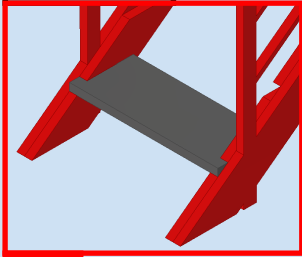

!

E10

34

E10(x10)

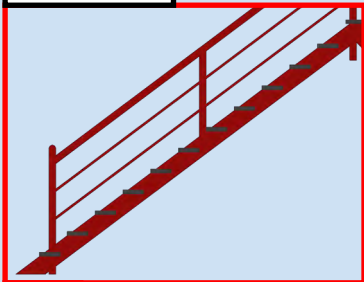

!

E10

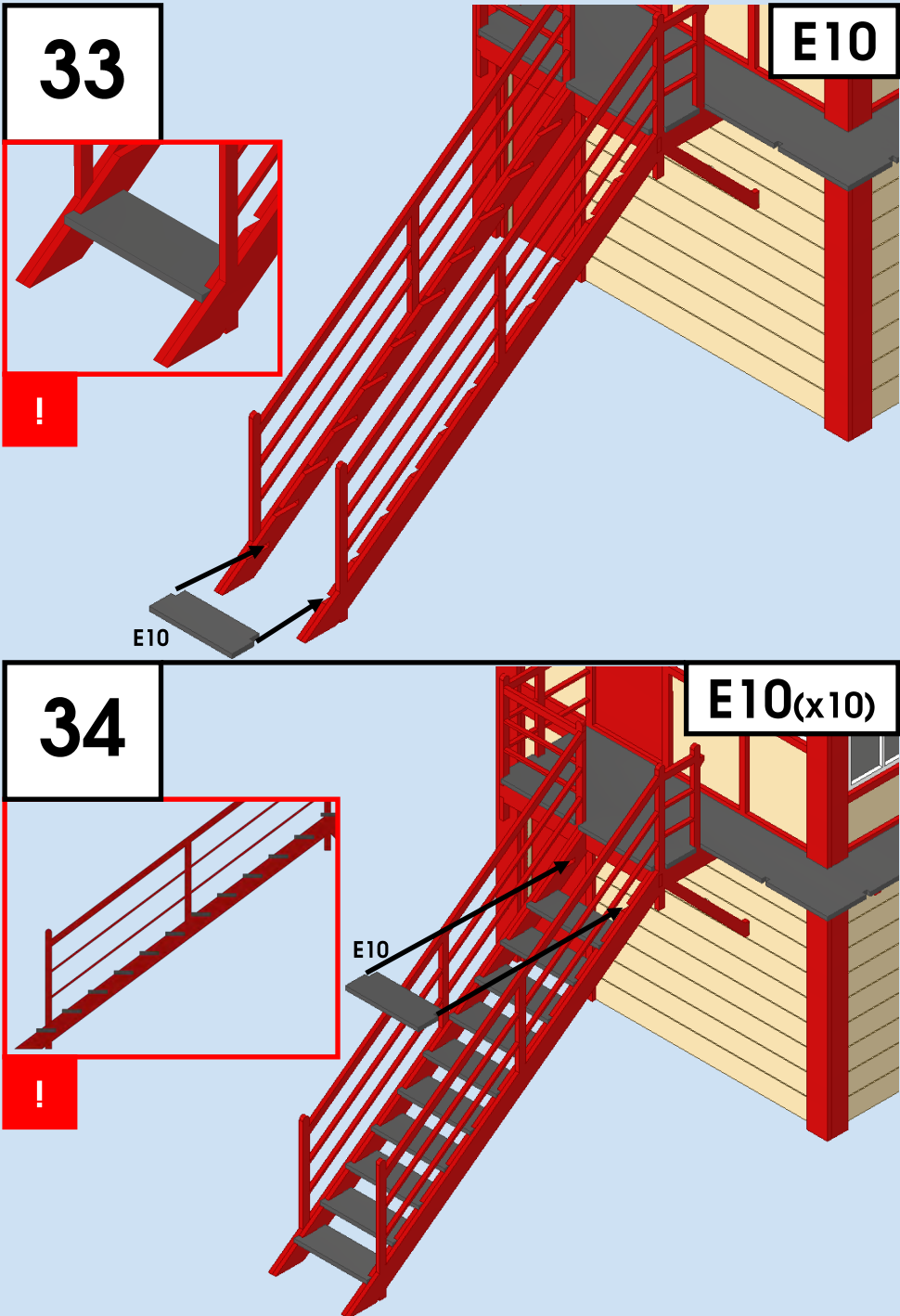

35

Wood Panels

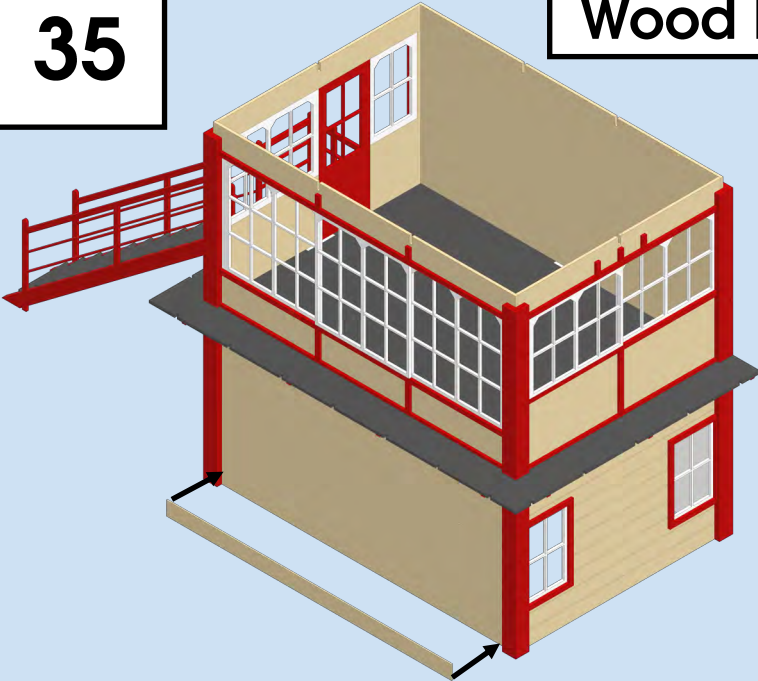

36

Wood Panels

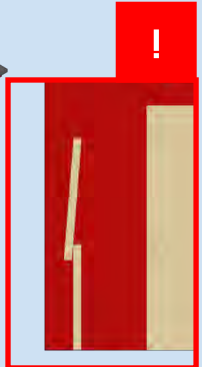
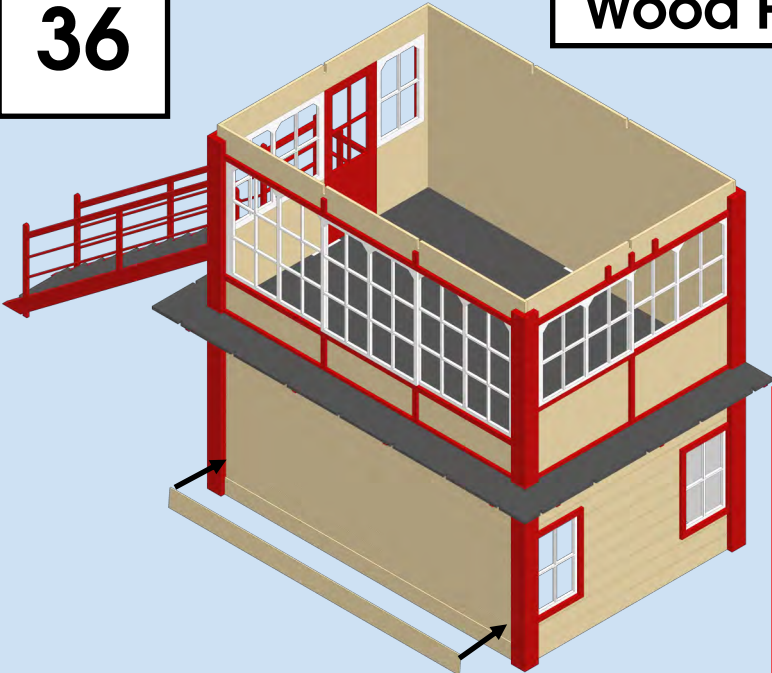

37

Wood Panels

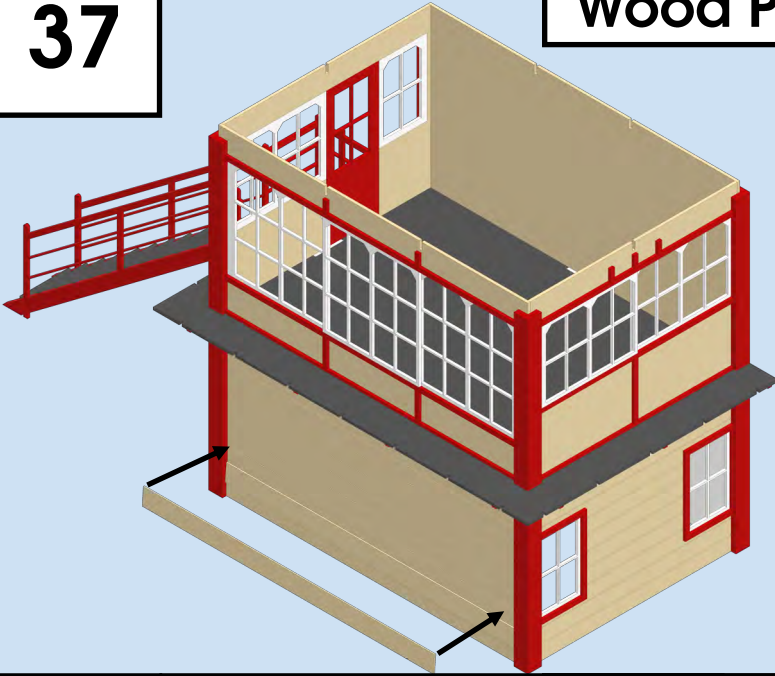

38

Wood Panels

x6

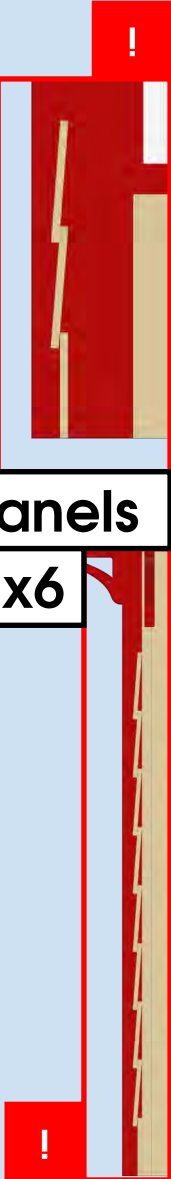
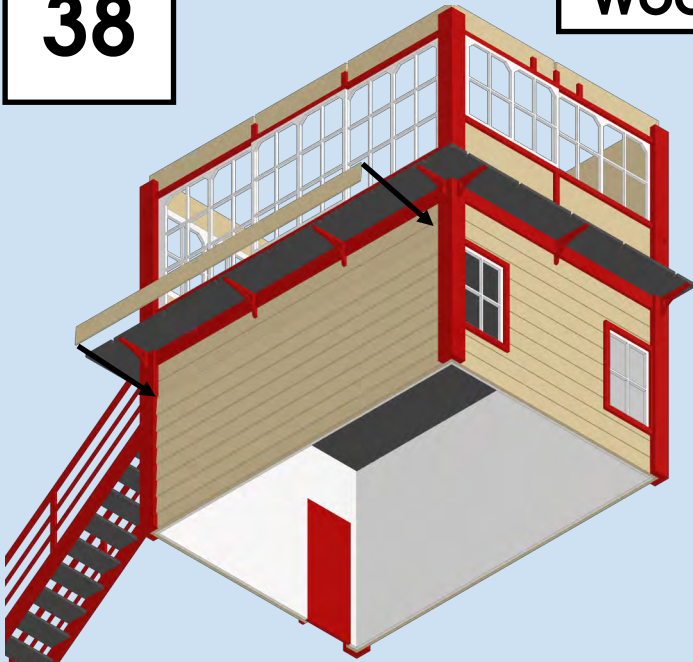

39

Wood Panels

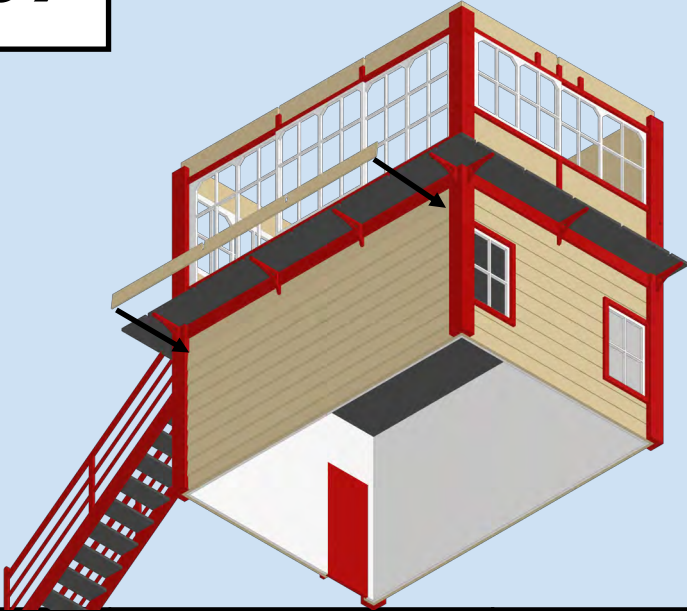

40

Wood Panels

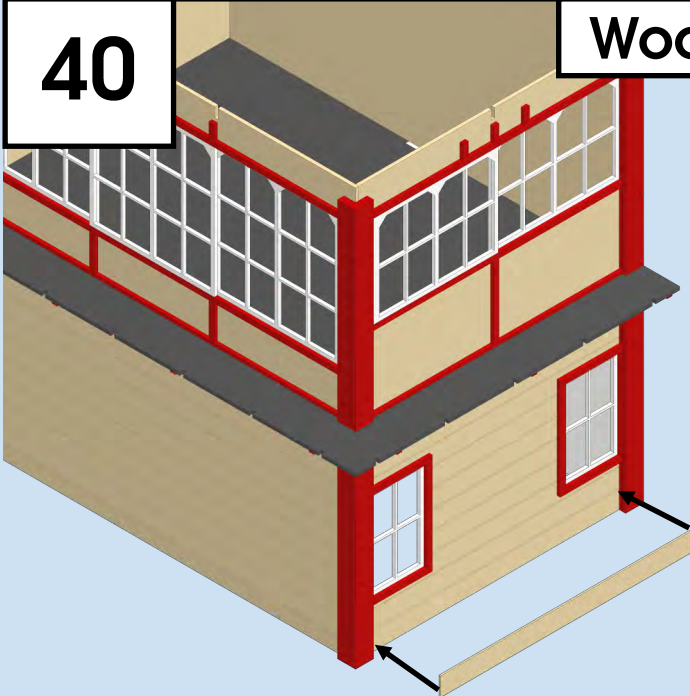

41

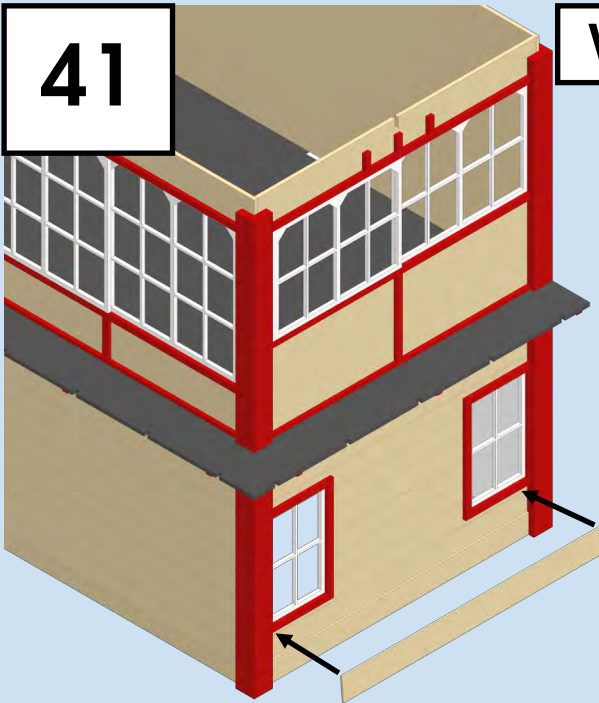

Wood Panels



42

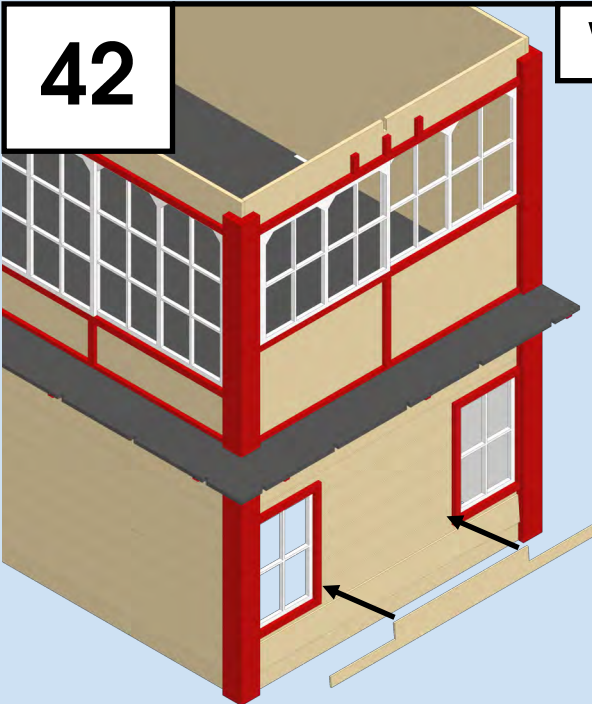

Wood Panels



43

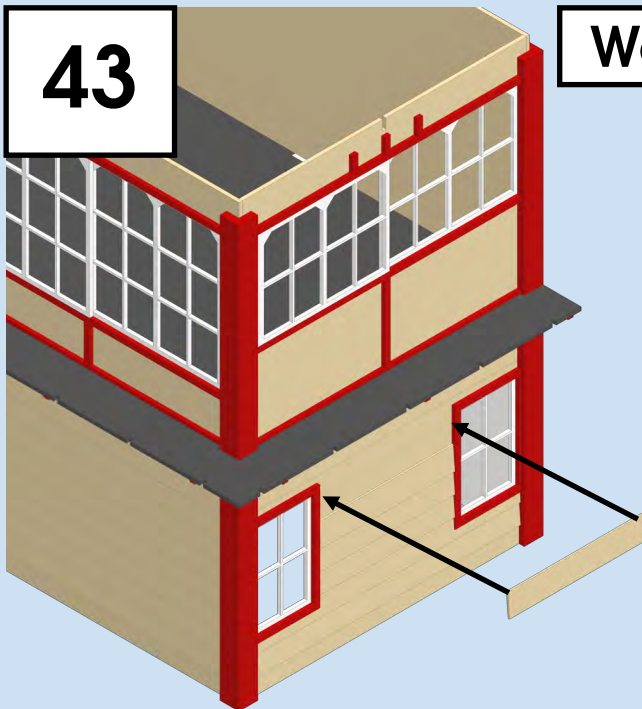

Wood Panels

x3

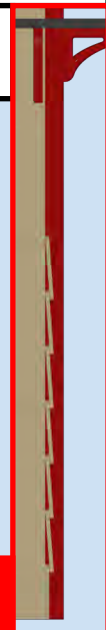

44

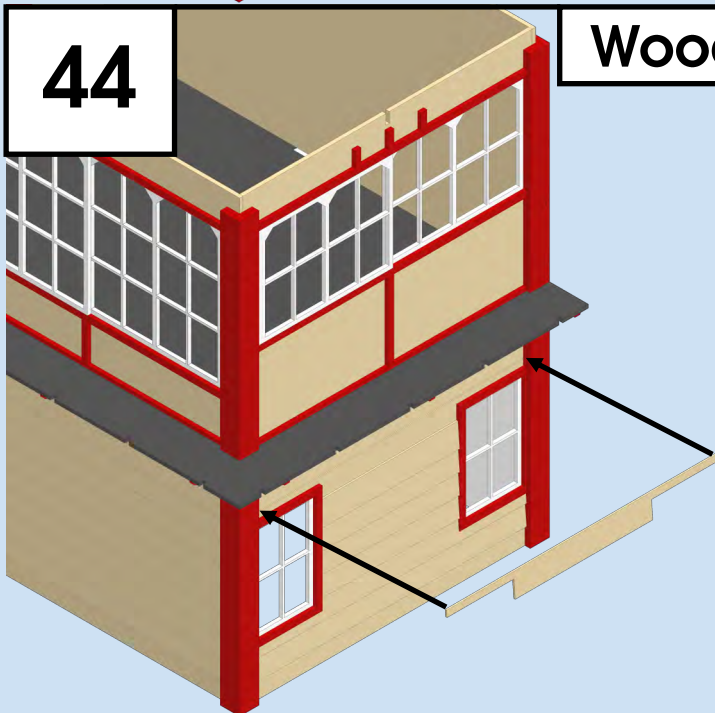

Wood Panels

45

Wood Panels

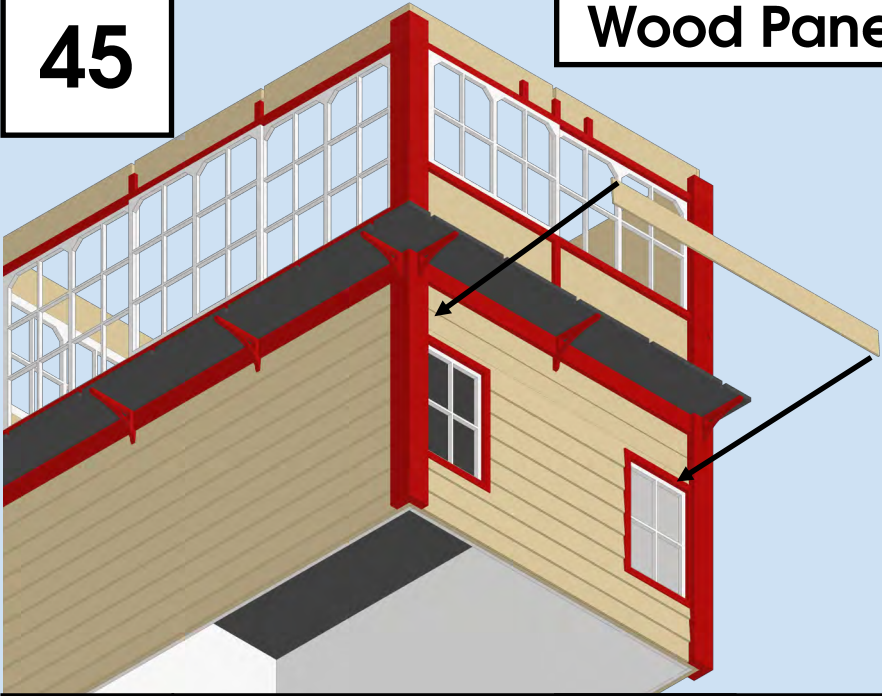

46

Wood Panels

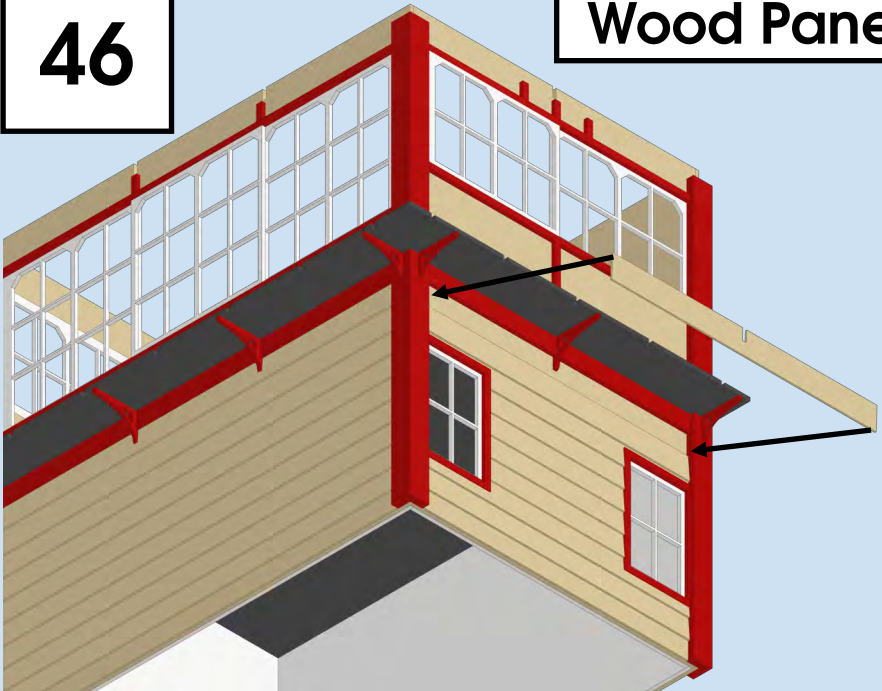

47

Wood Panels

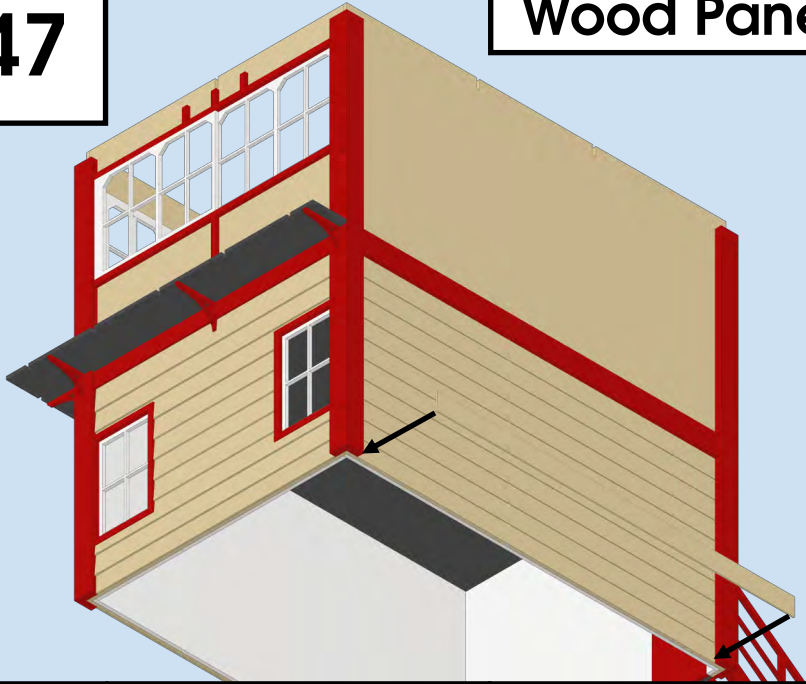

48

Wood Panels

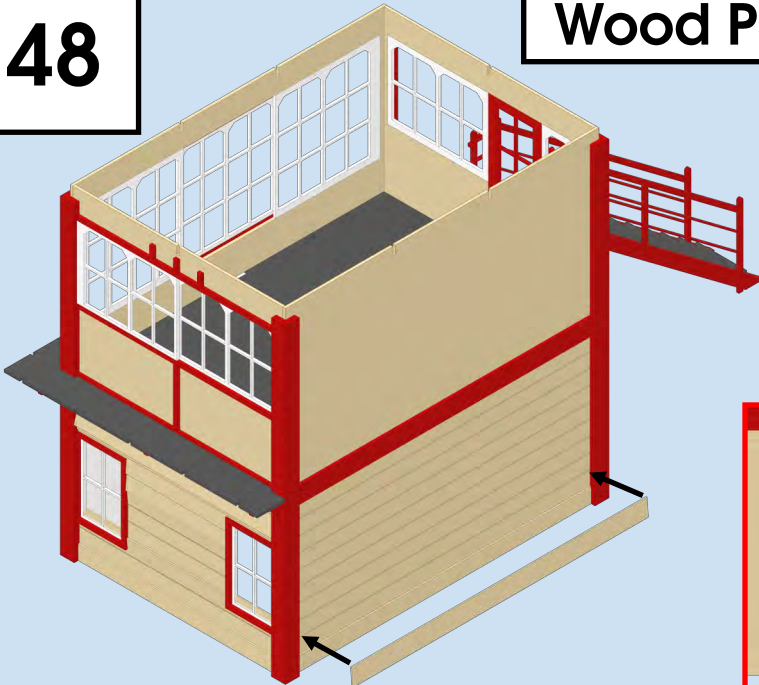

49

Wood Panels

x8

!

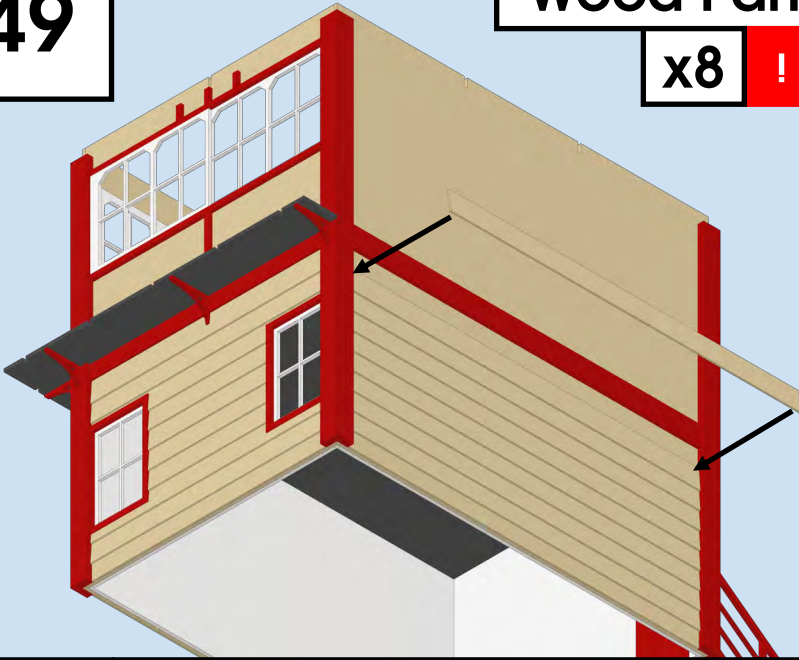

50

G12

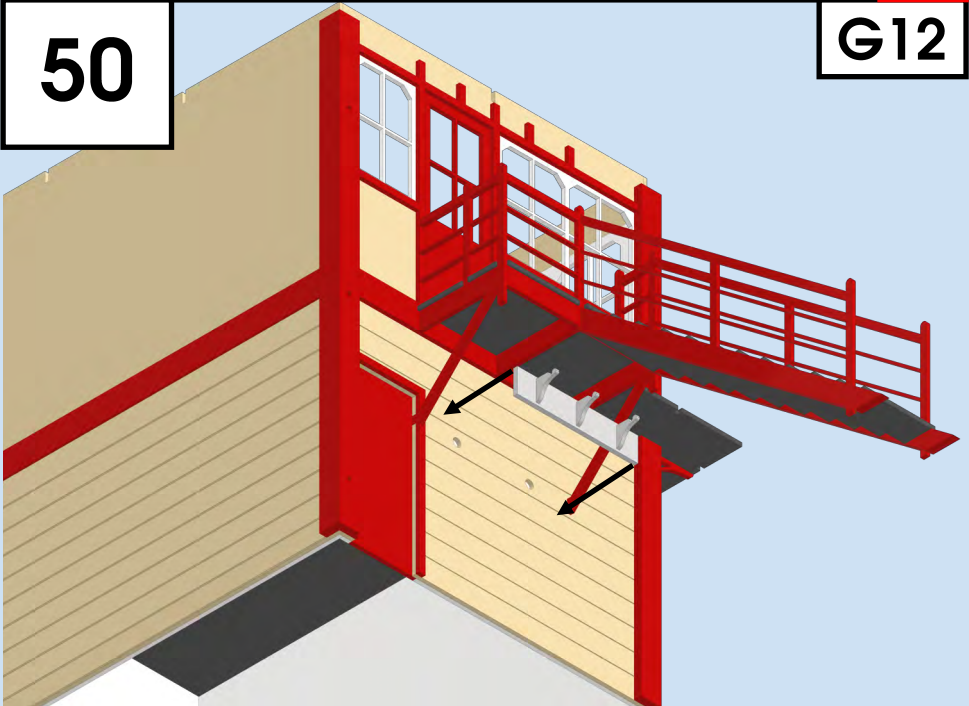

51

Wood Panels

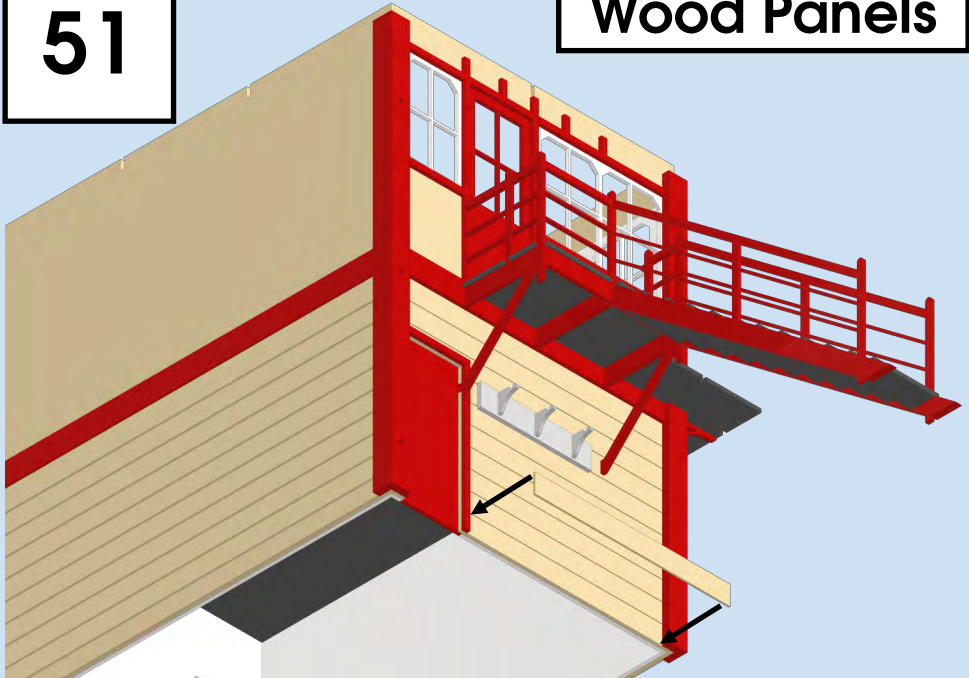

52

Wood Panels

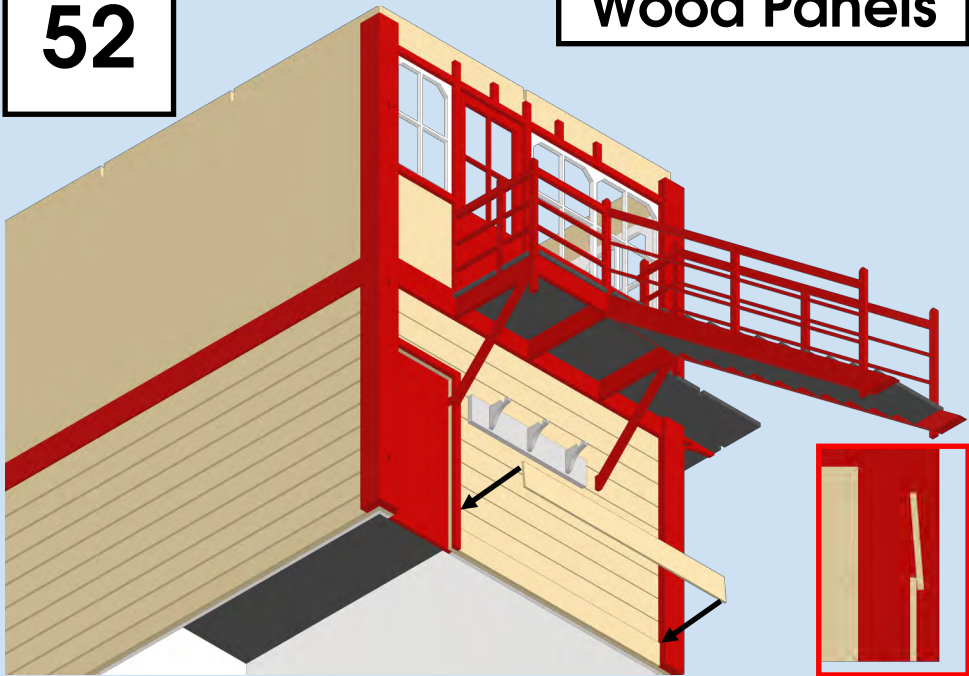

53

Wood Panels

x3

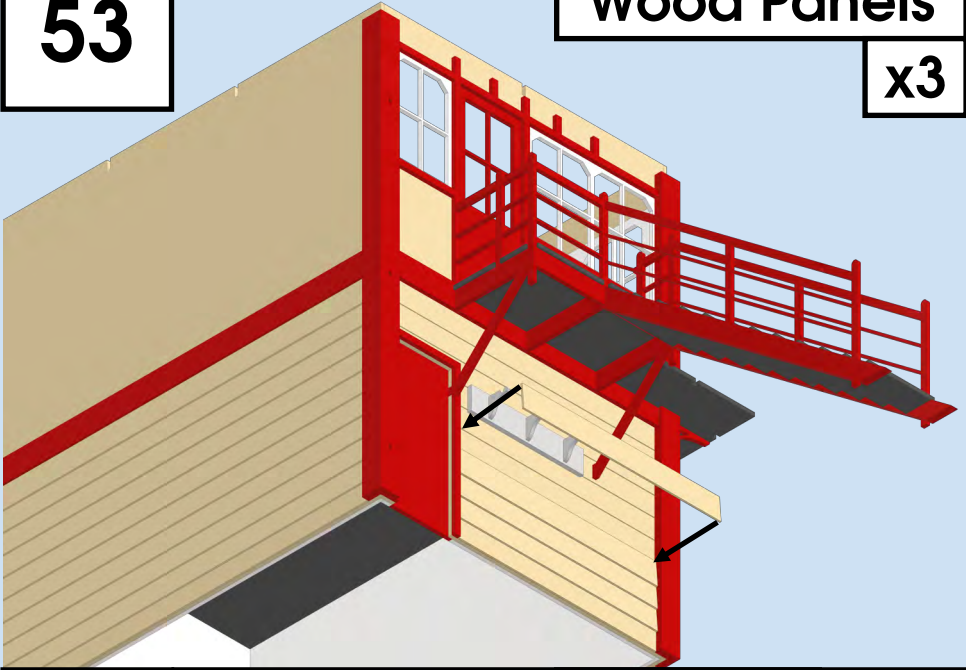

54

Wood Panels

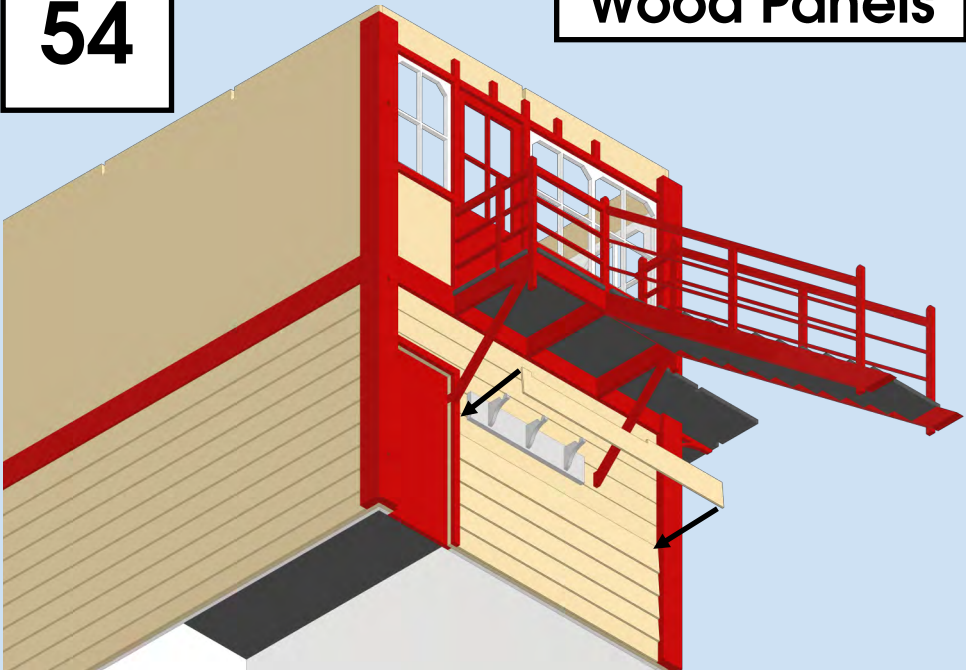

55

Wood Panels

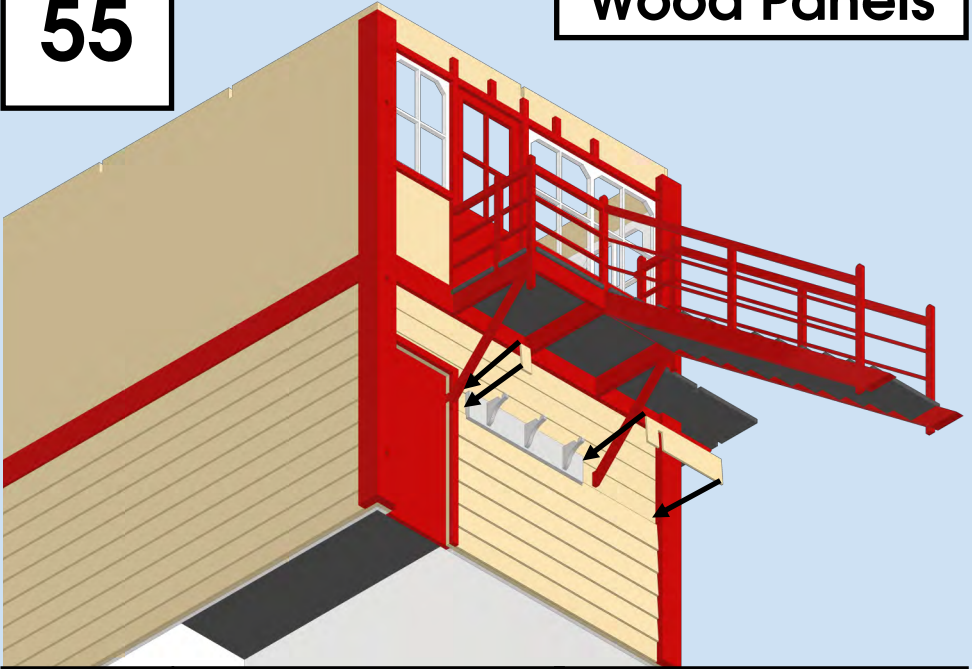

56

Wood Panels



57

Wood Panels

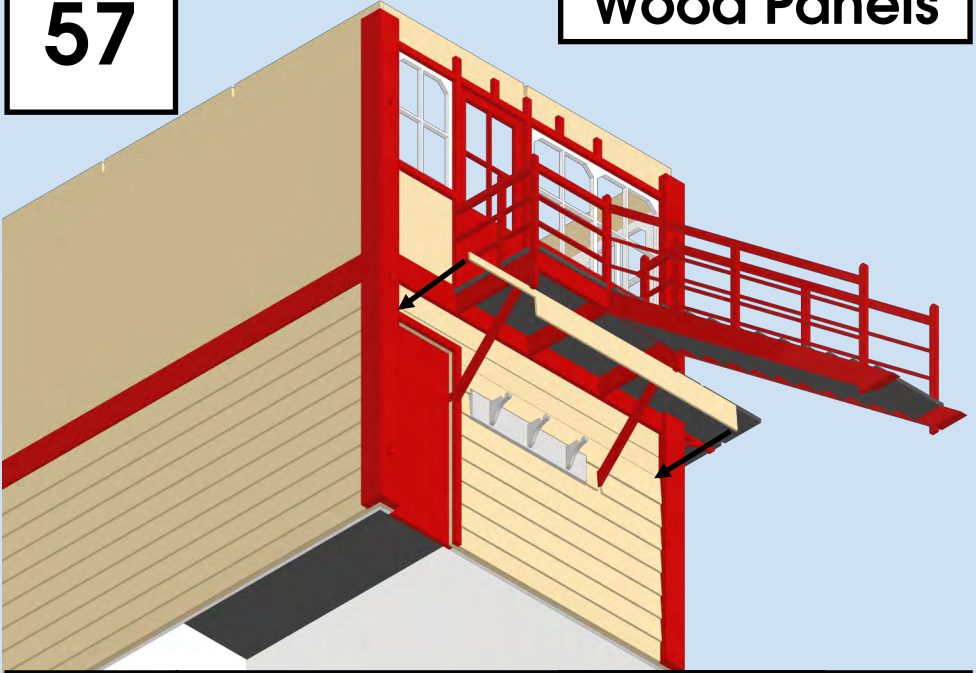

58

Wood Panels

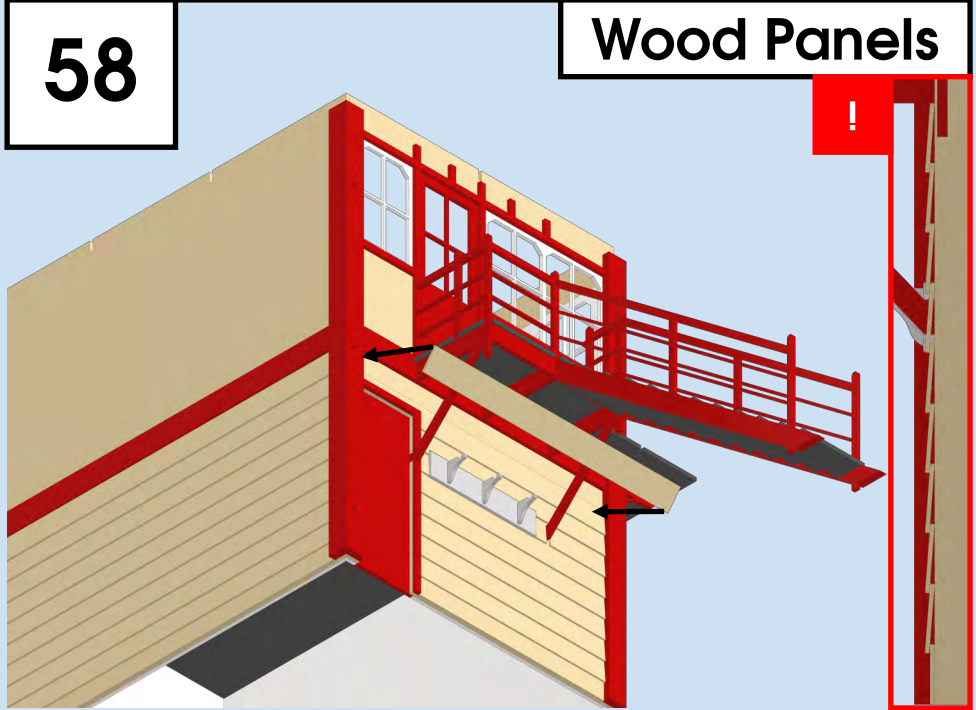



**59**

**G4 & G7**

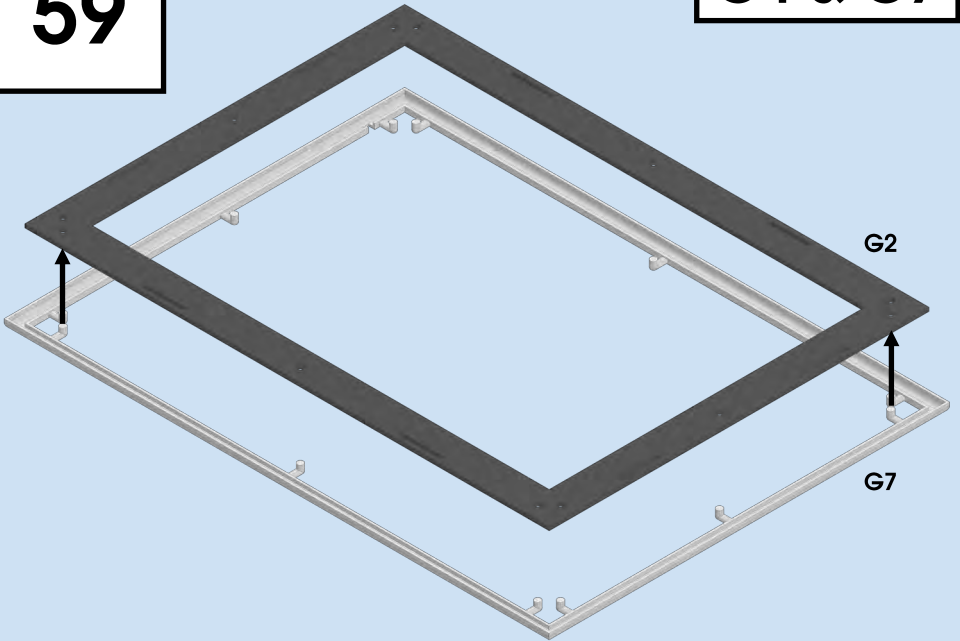

**60**

**G & G8(x2)**

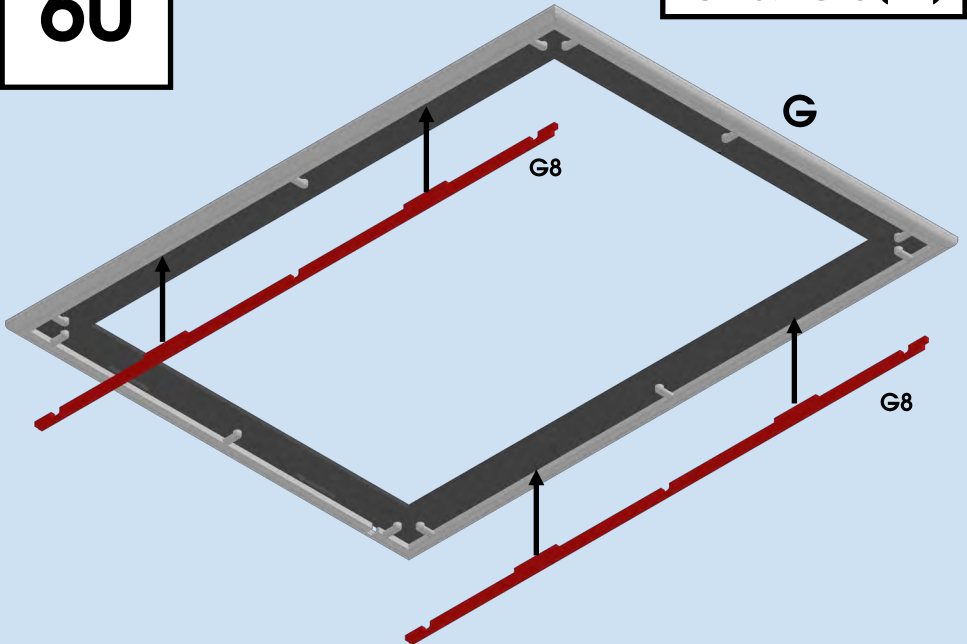

61

G & G9(x2)

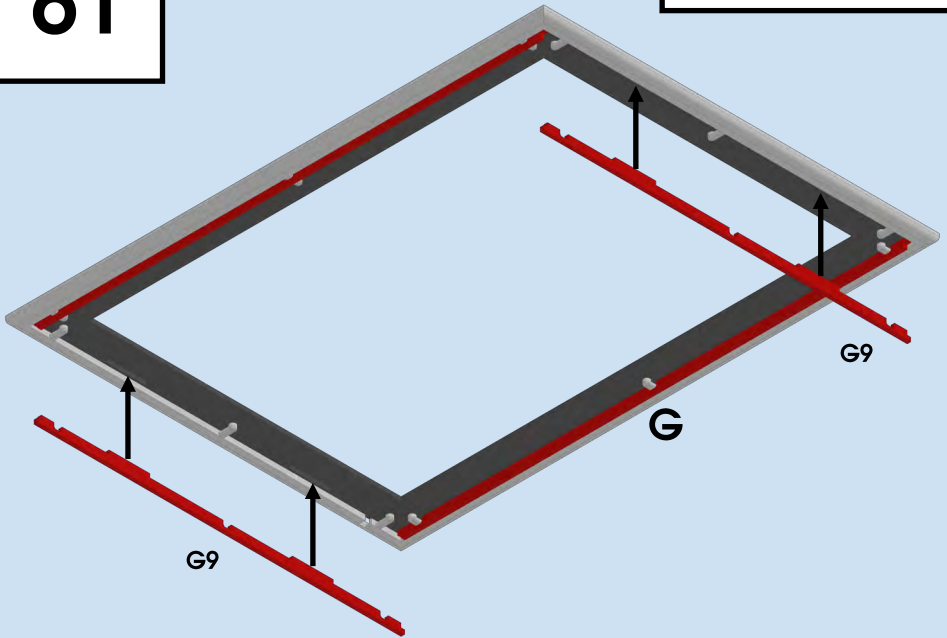

62

G

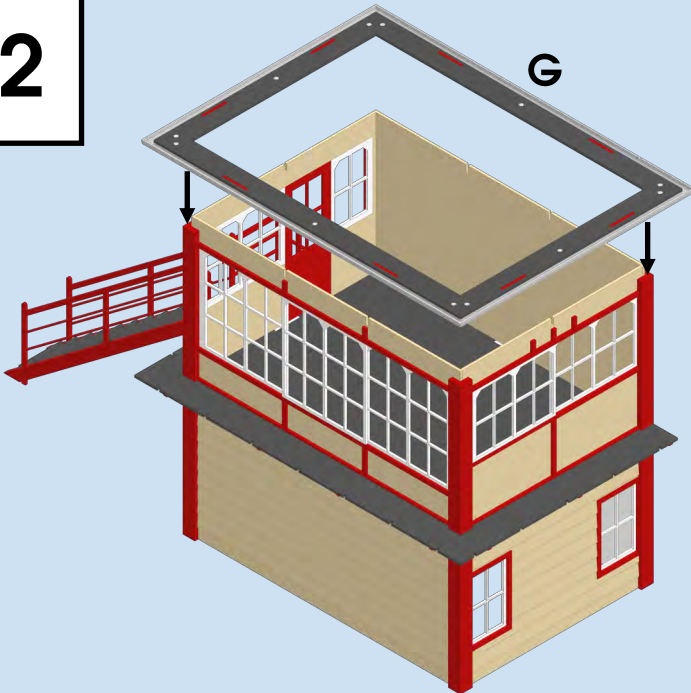

63

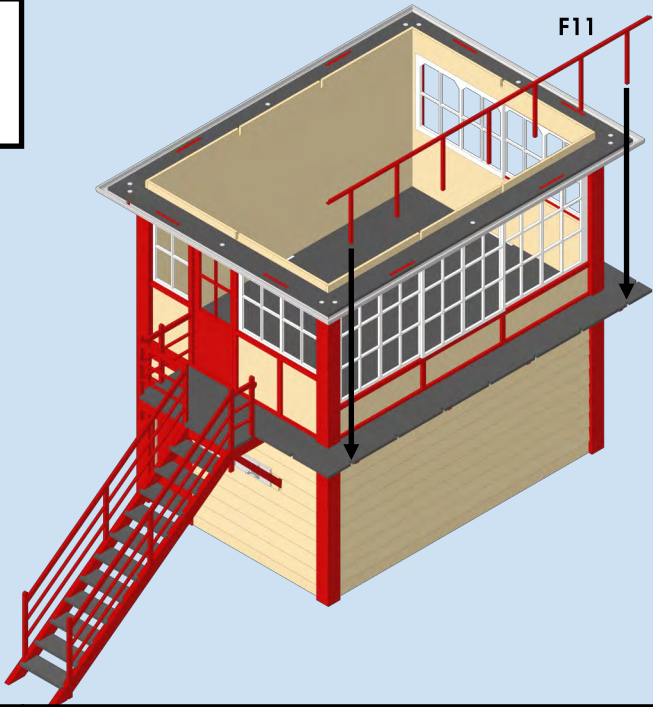

F11

64

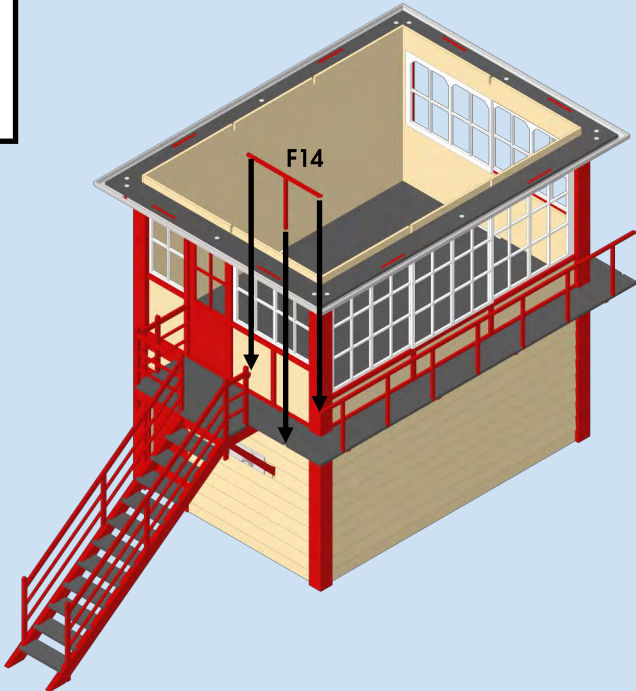

F14

65

F12

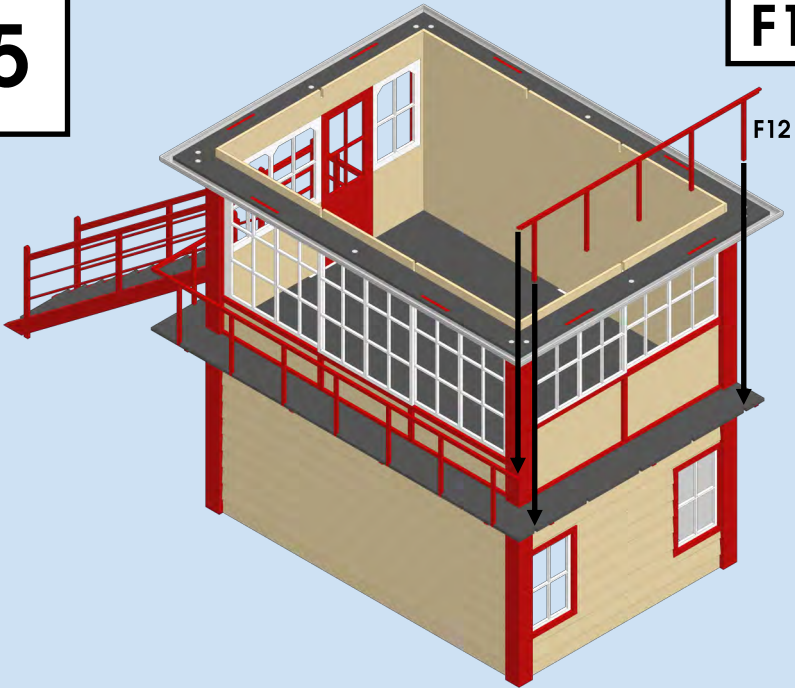

66

F13

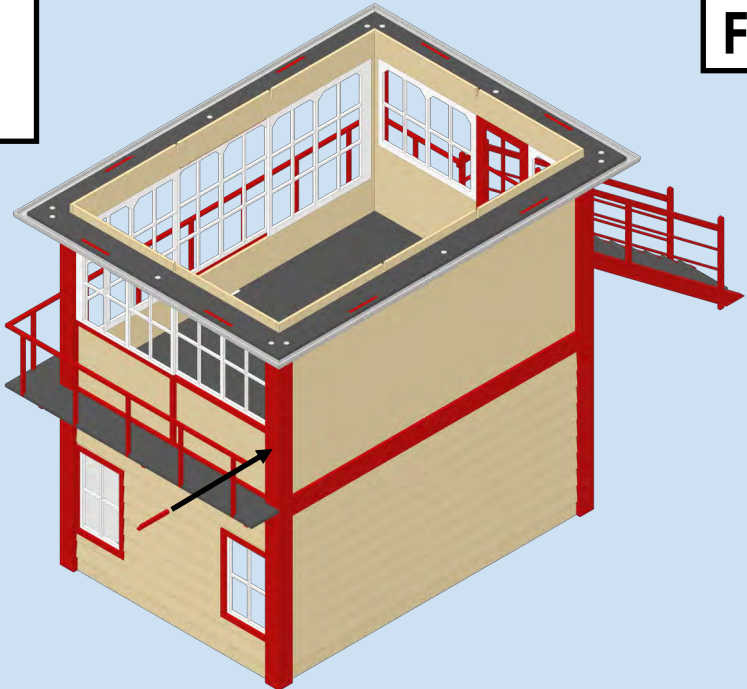

67

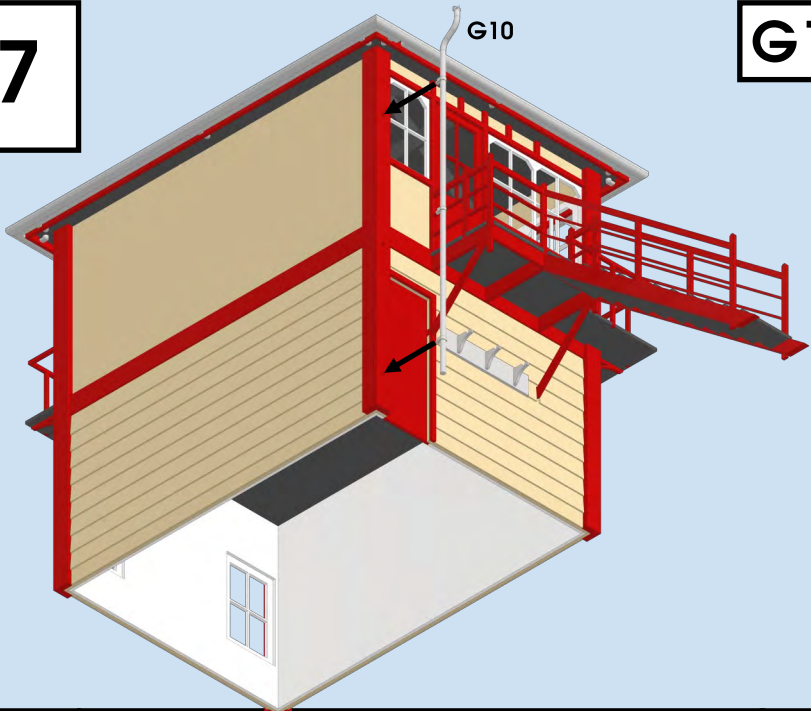

G10

68

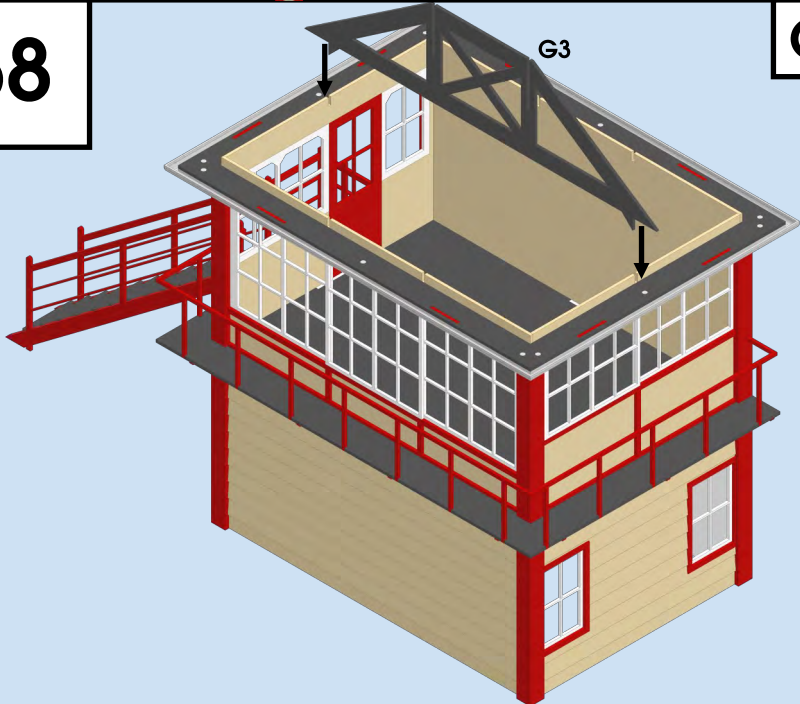

G3

69

G4(x2)

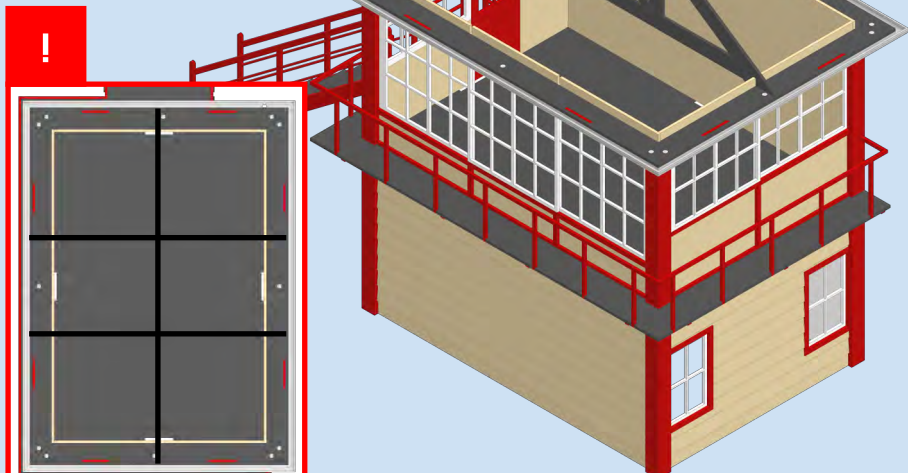

70

G5(x2)

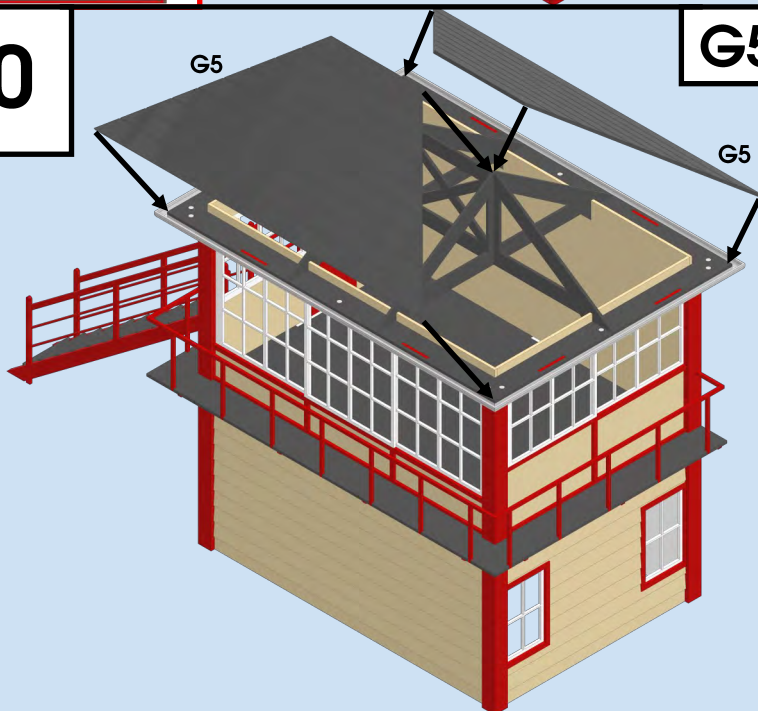

71

G6(x2)

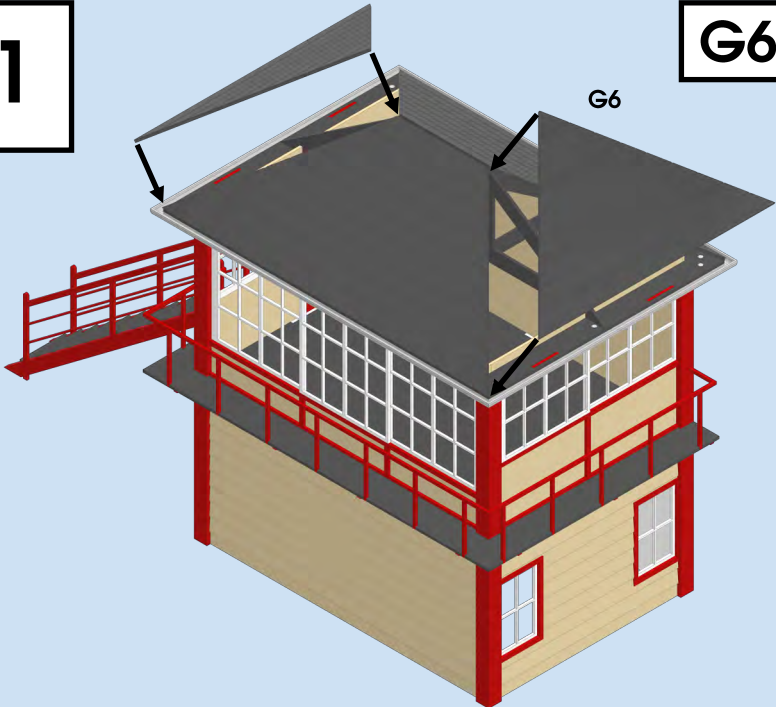

72

Tiles

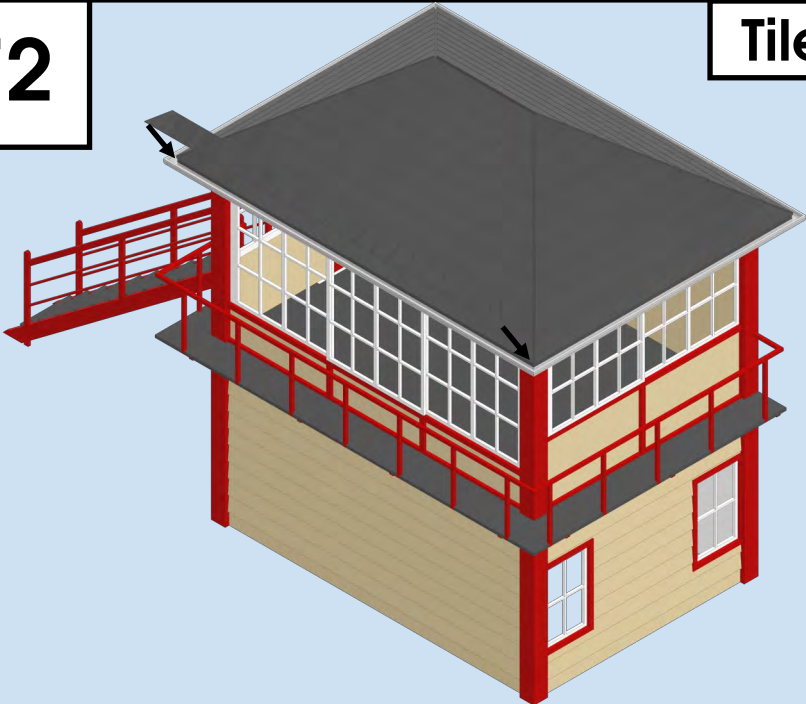

73

Tiles

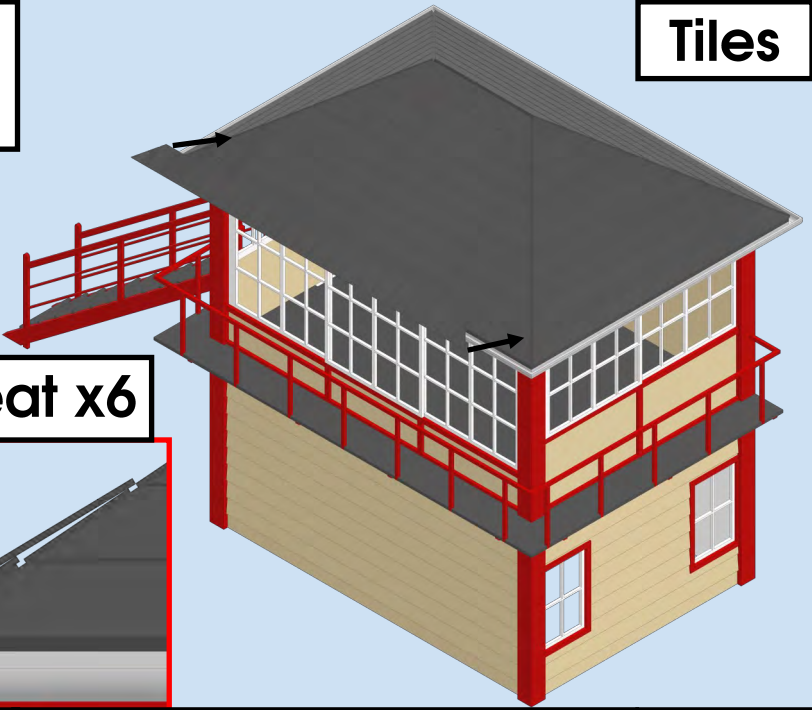

Repeat x6

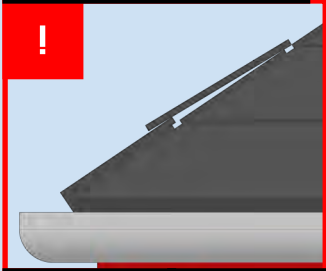

74

Tiles

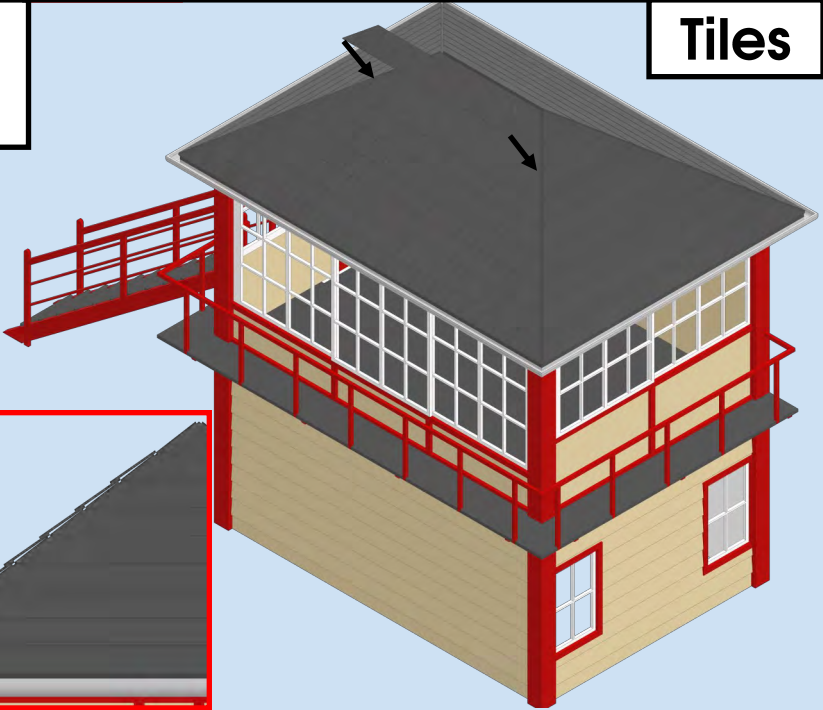



75

Tiles

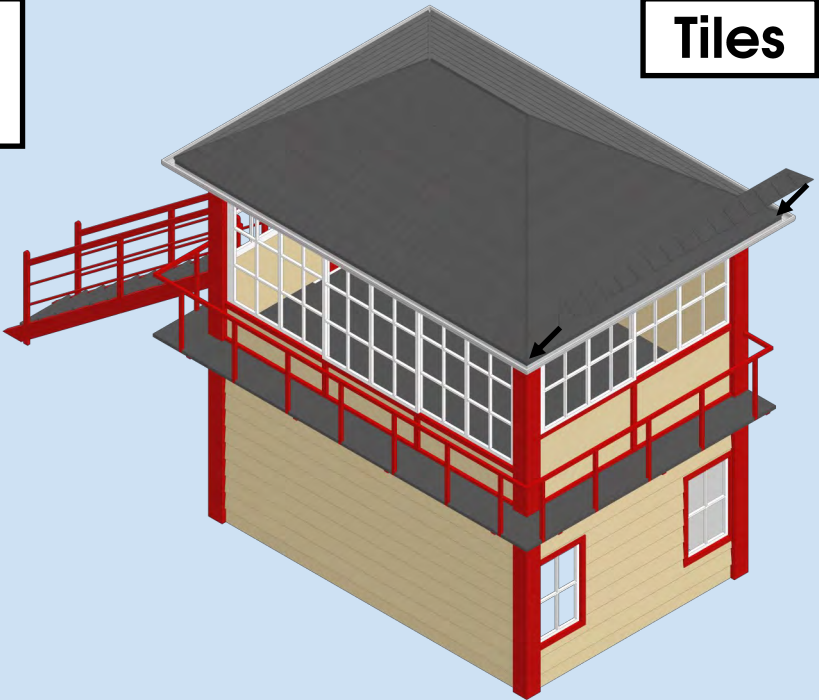

76

Tiles

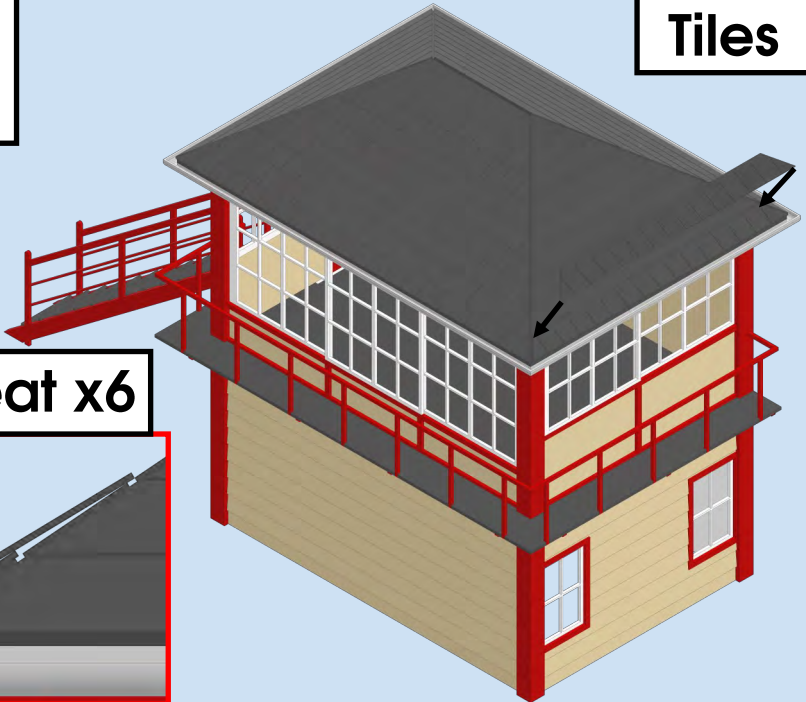

Repeat x6

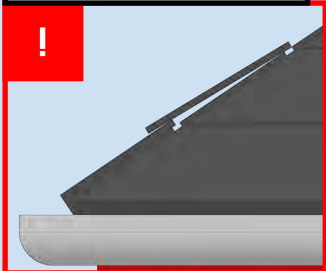

**77**

**Tiles**

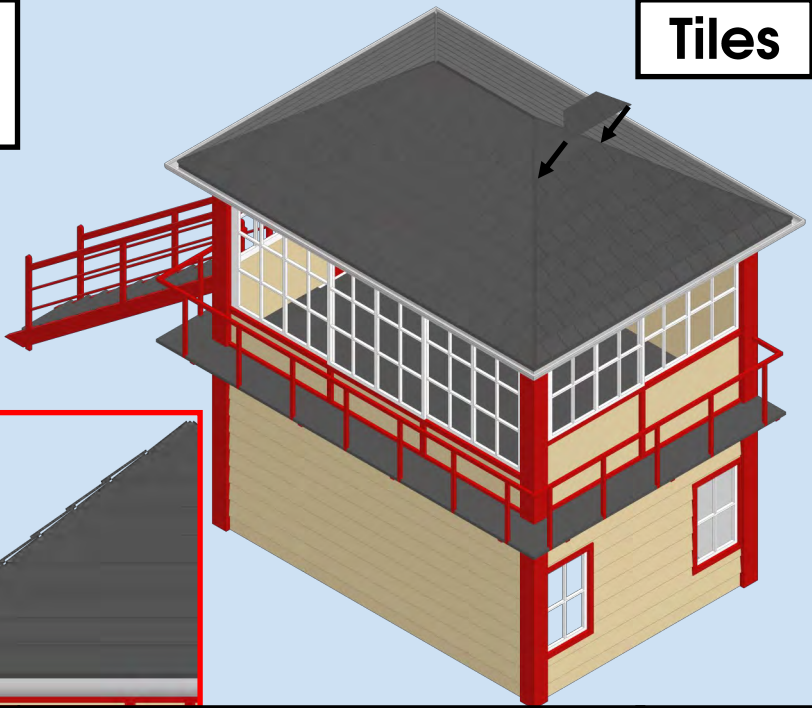

**78**

**Tiles**

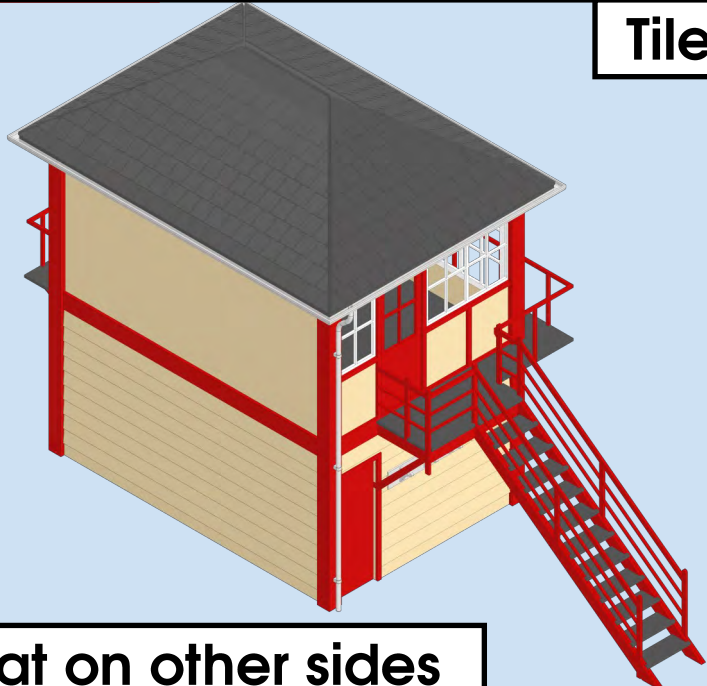

**Repeat on other sides**

79

Tiles

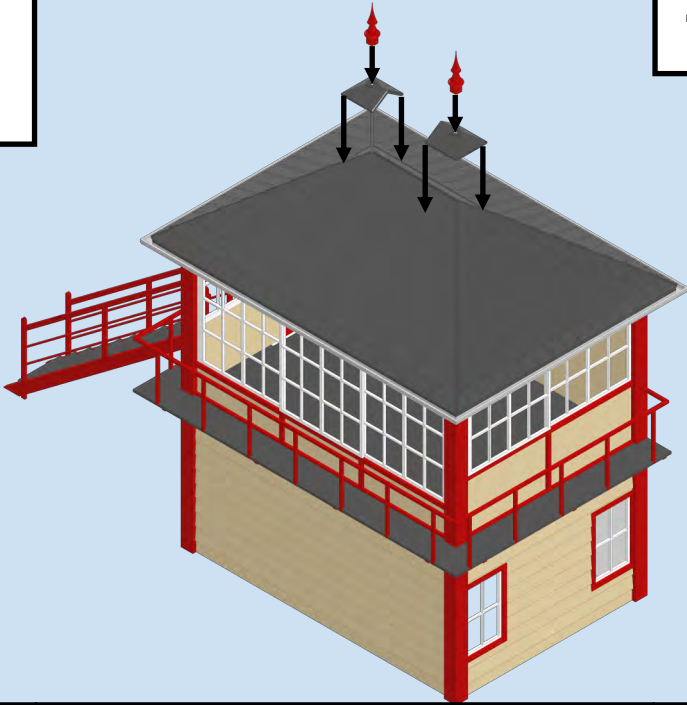

80

Tiles

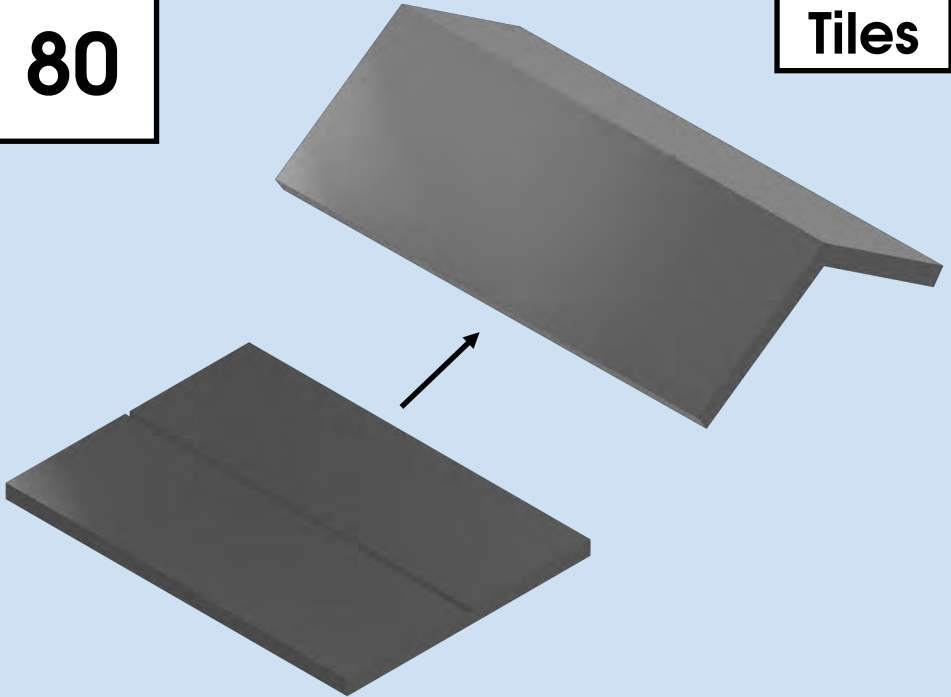

**81**

**G12**

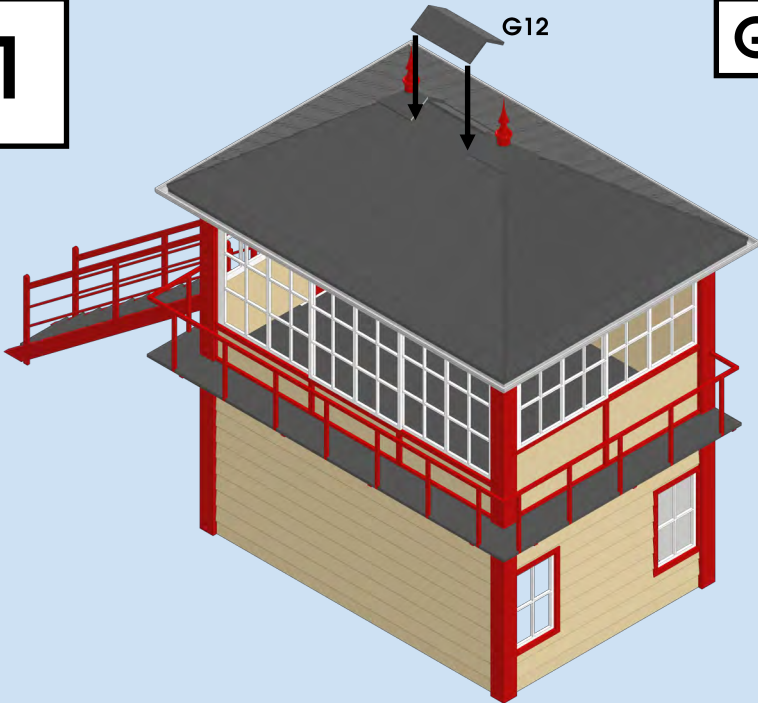

**82**

**G11(x2)**

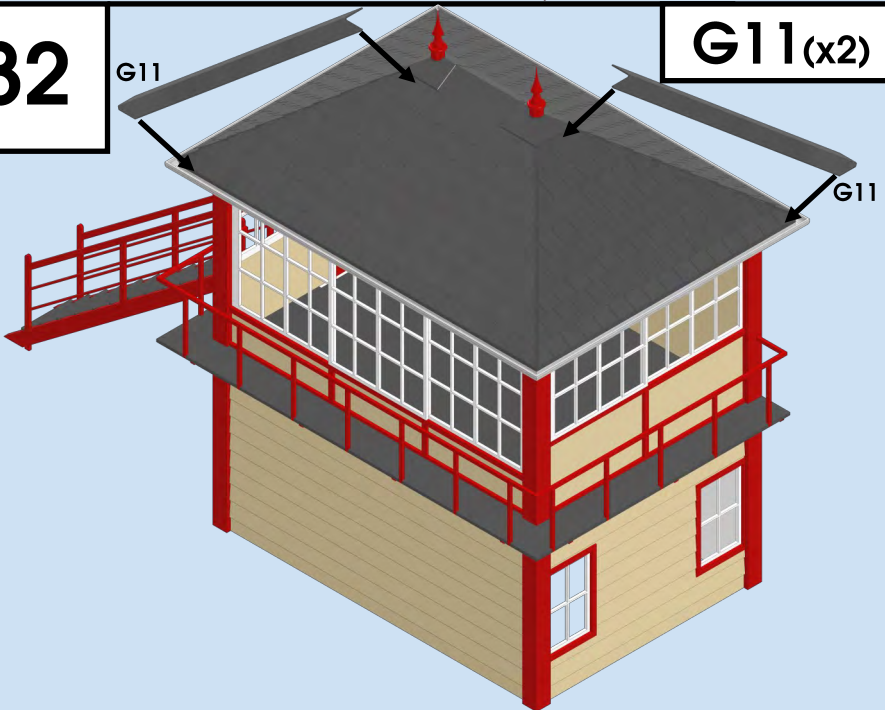

83

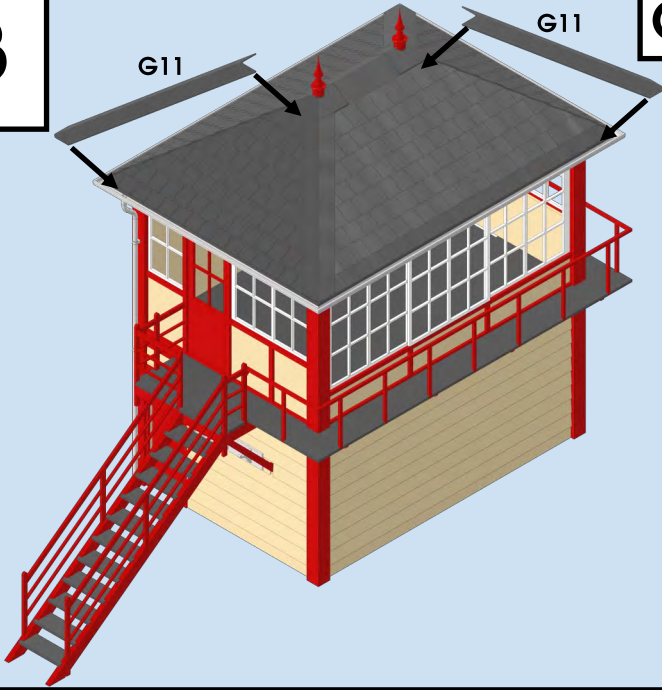

G11(x2)



The logo for 'dapol' is centered on a blue background. The text 'dapol' is written in a lowercase, italicized, sans-serif font. The letters are enclosed within a thin, light gray rectangular border that follows the slant of the text. The background is a solid blue color, with a white curved line separating it from a gray area on the left side.

*dapol*