

dapol

Gauge

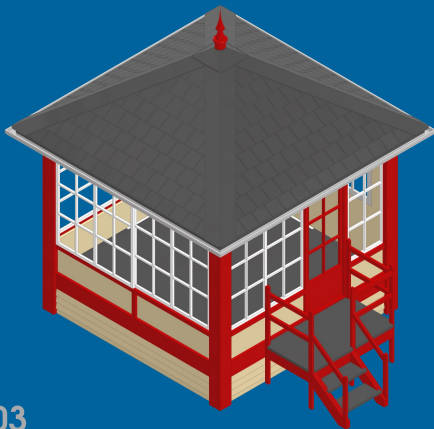

7B-001-003

Midland Railway Small Signal Box

Based on Oddingley, Worcestershire



Read Before Building

Estimated Build Time:
6-7 hours

This is a very complex kit, we strongly recommend taking your time building it. It is also very important to keep a clean work area as the card is permeable and can stain very easily.

We recommend using a standard PVA glue slightly diluted with water. We do not recommend any fast drying glues, as they can dry too quickly, making any small positional adjustments difficult. It's best to apply the glue using a small paintbrush or cardboard offcut.

Parts cannot be bought individually. Spare or replacement frets can be bought £10 each for large frets and £7 each for small frets by contacting sales@dapol.co.uk

Printed instructions are available free of charge by contacting sales@dapol.co.uk

But most of all. Enjoy.

Checklist

- China White 1
 - A1
- China White 2
 - B1
- China White 3
 - C1
- China White 4
 - D1
- China White Thin 1
 - J1 (x12)
 - J2 (x4)
- Clear 3
 - E1 (x2)
 - E2 (x2)
 - E3
 - E4
 - E5
 - E6
- Scarlet 1
 - A3
 - A4 (x2)
 - E6
 - F4
 - G2 (x2)
 - G3 (x2)
- Scarlet 2
 - B3
 - B4 (x2)
 - F1
 - F2
 - F3
 - F6(x2)
- Scarlet 3
 - C3
 - C4 (x2)
 - D4
 - D5
- Scarlet 4
 - D3
- Slate 3
 - F5
 - F7 (x2)
 - G1
- Slate 4
 - H3
 - H4
 - H5 (x2)
- Slate 5
 - H1
- Slate 6
 - H5 (x2)
- Slate Thin 3
 - Tiles
 - H9
- White 12
 - A2
 - B2
 - C2
 - D2
- White 6
 - E1 (x2)
 - E2 (x2)
- White 7
 - E3
 - E4
 - E5

1

A1 & A3

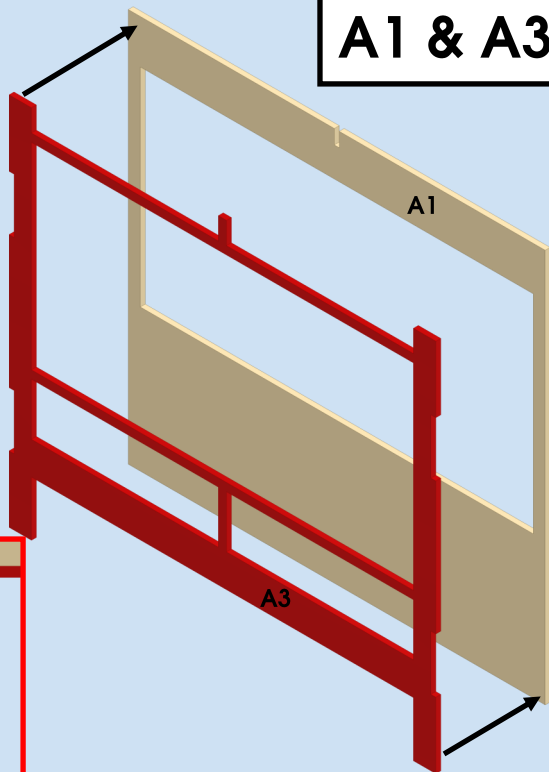
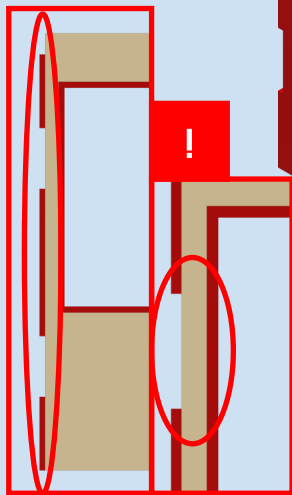

2

A & A3

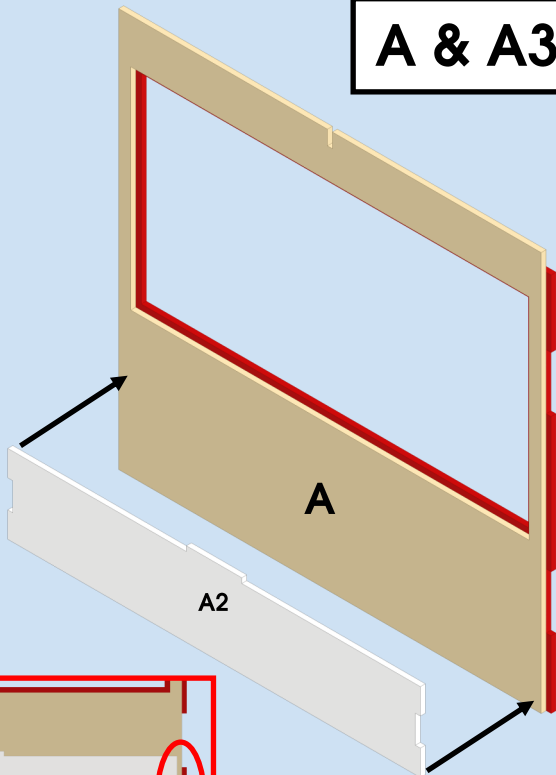

3

A & E2 (frame & glazing)

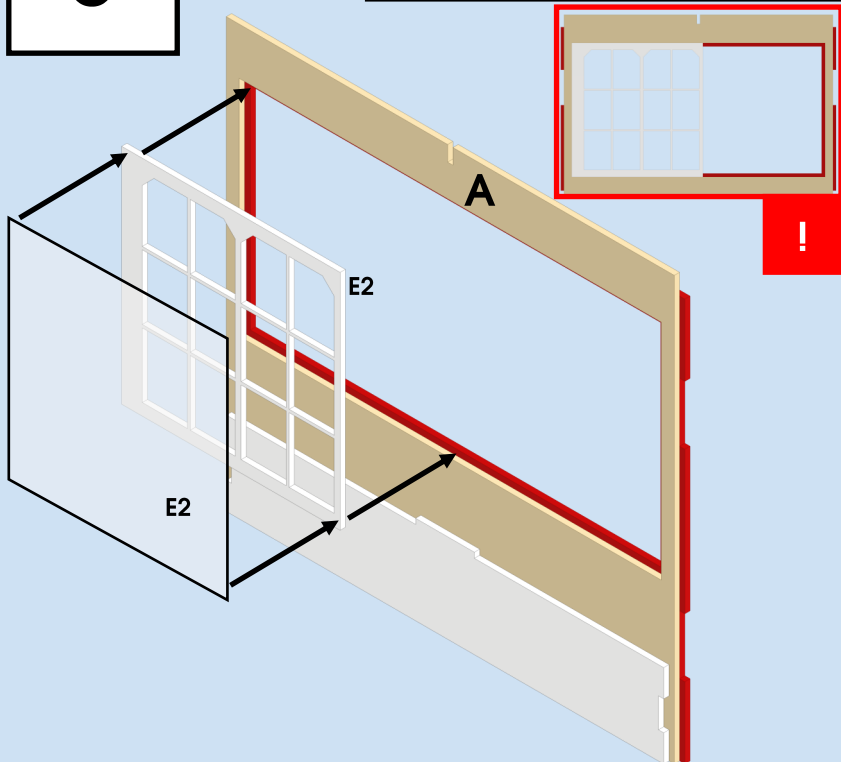

4

A & E1 (frame & glazing)

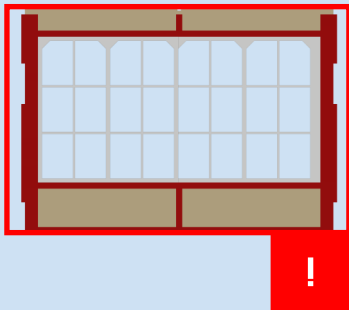
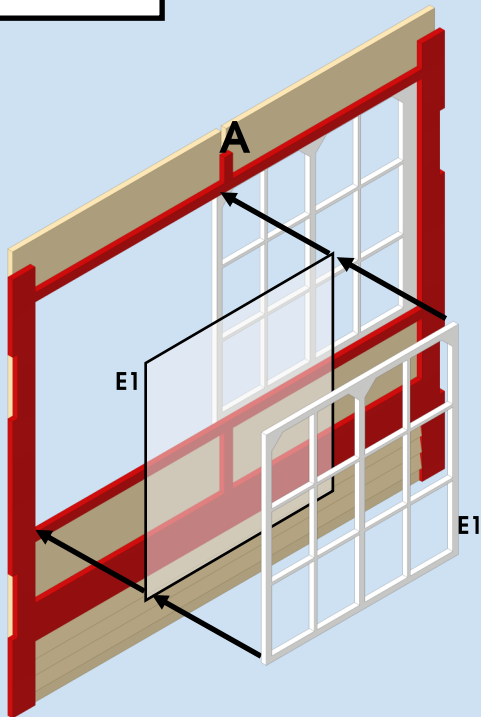

5

B1 & B3

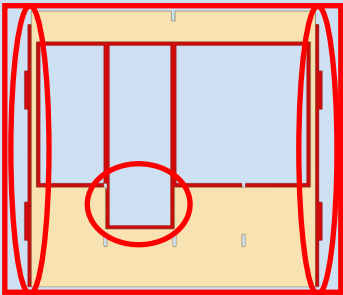
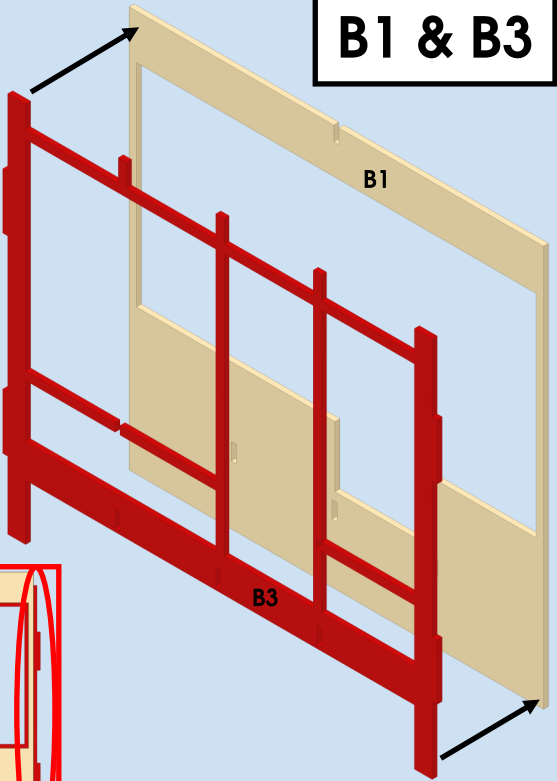

6

B & B2

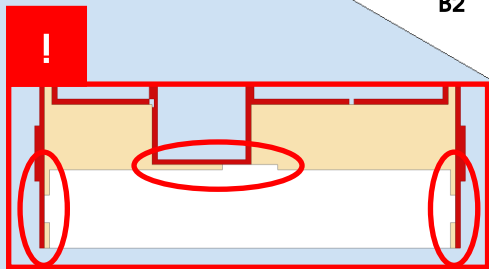
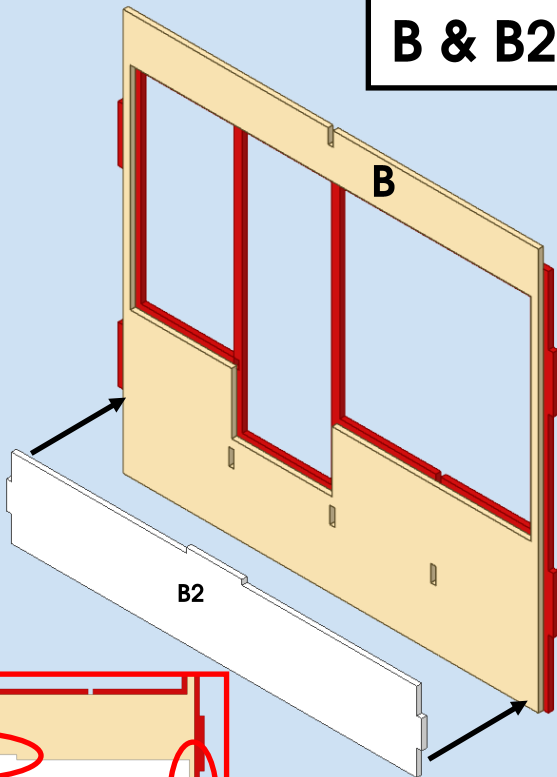

7

B, **E4**(frame & glazing) & **E5**(frame & glazing)

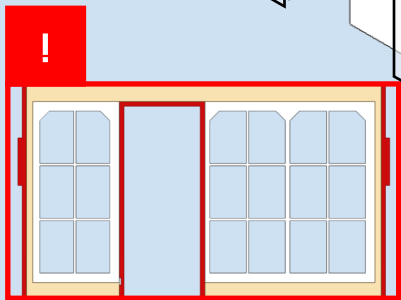
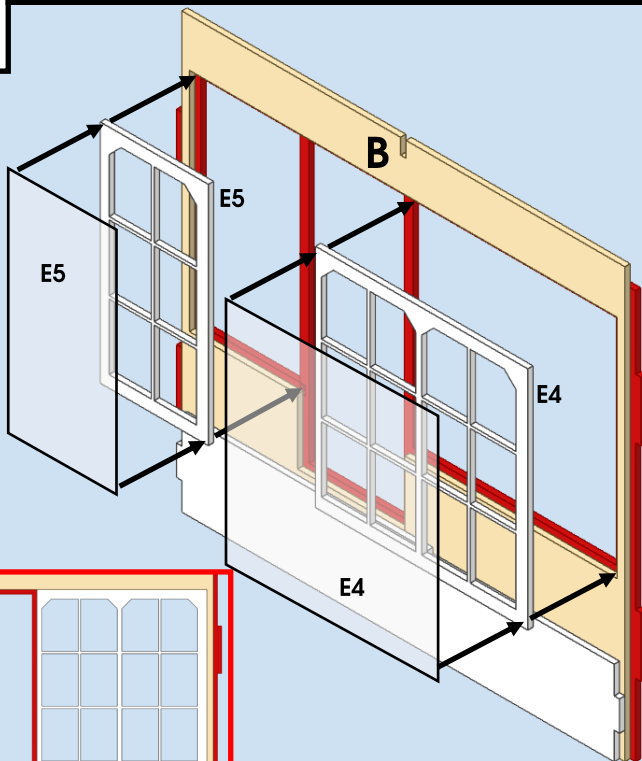

8

B & B6 (frame & glazing)

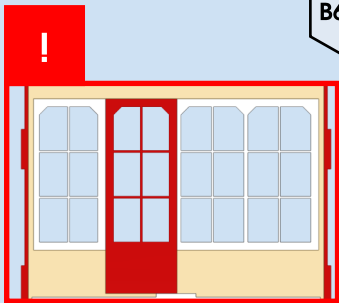
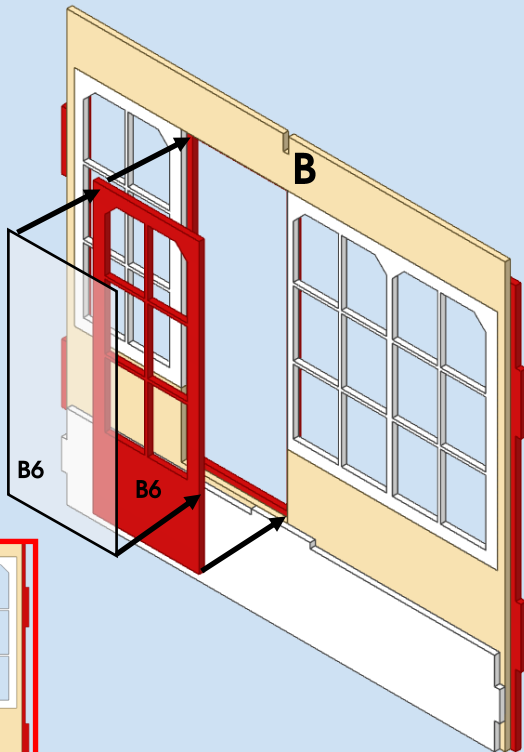

9

C1 & C3

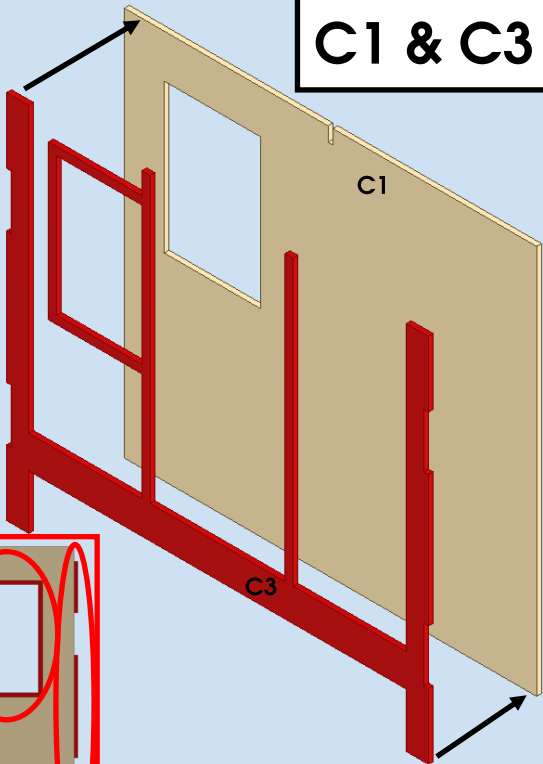

C1

C3

!

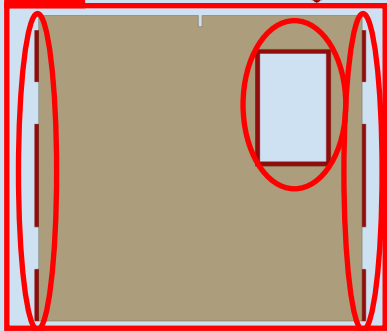

10

C & C2

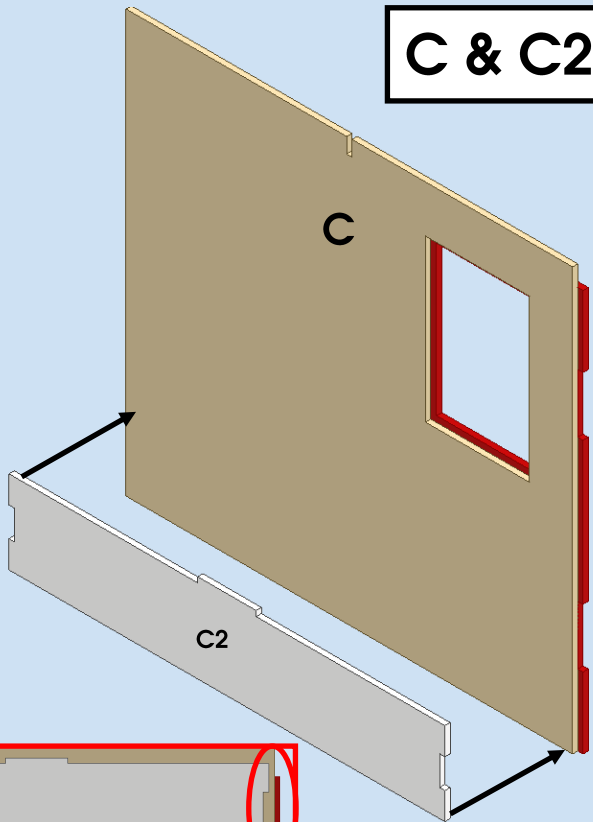

11

C & E3 (frame & glazing)

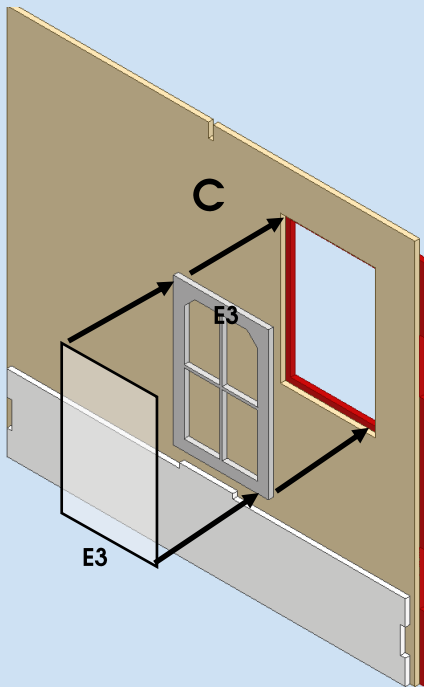

12

D1 & D3

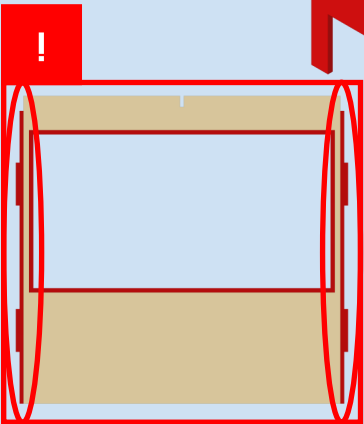
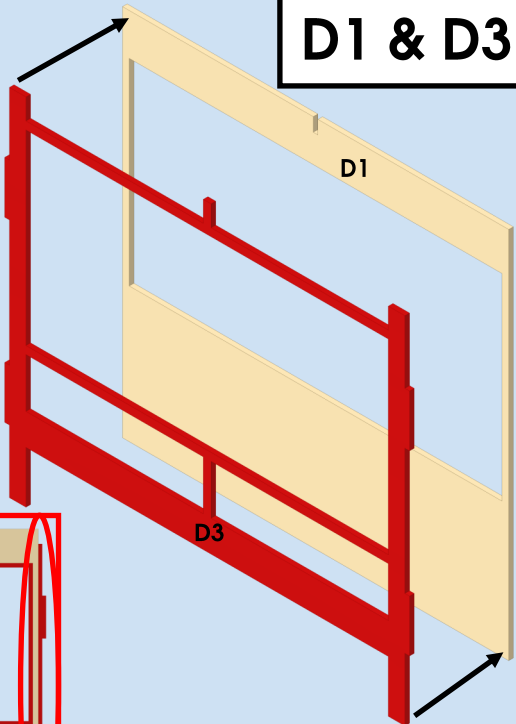

13

D & D2

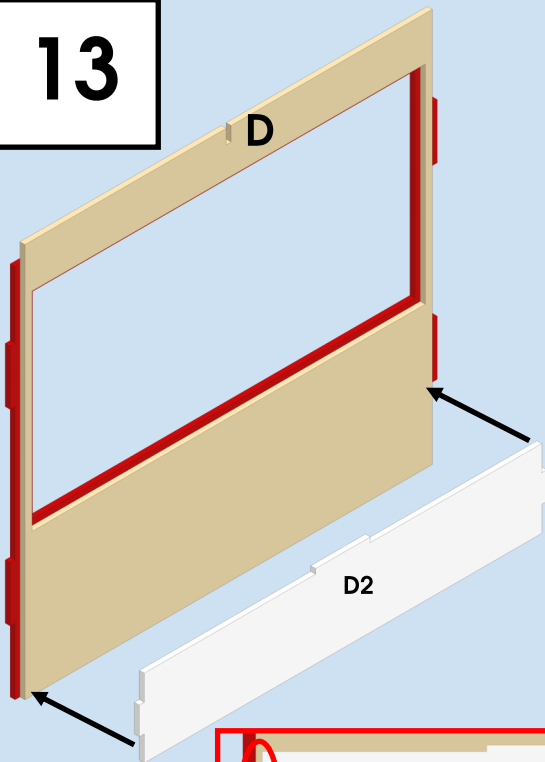

14

D & E2 (frame & glazing)

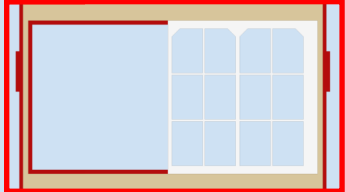
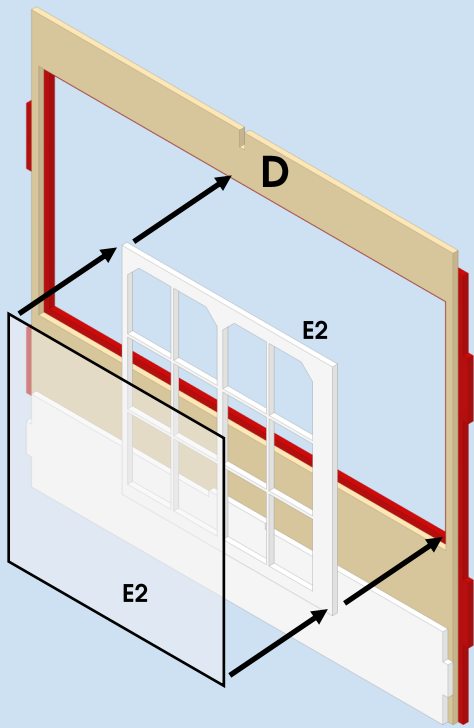

15

D & E1 (frame & glazing)

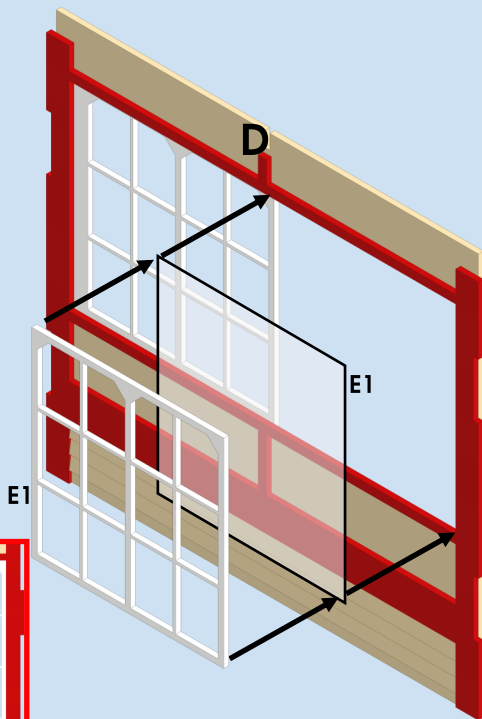
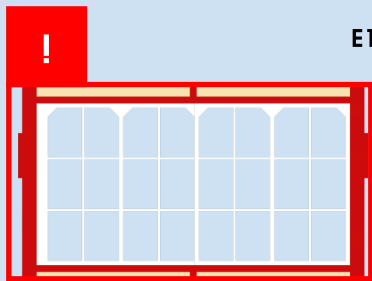

16

A & B

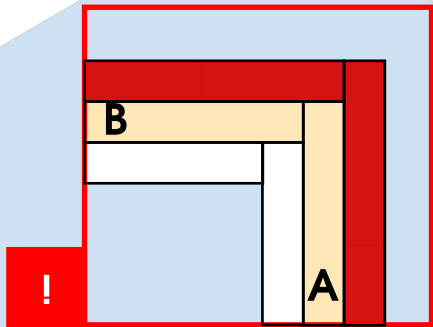
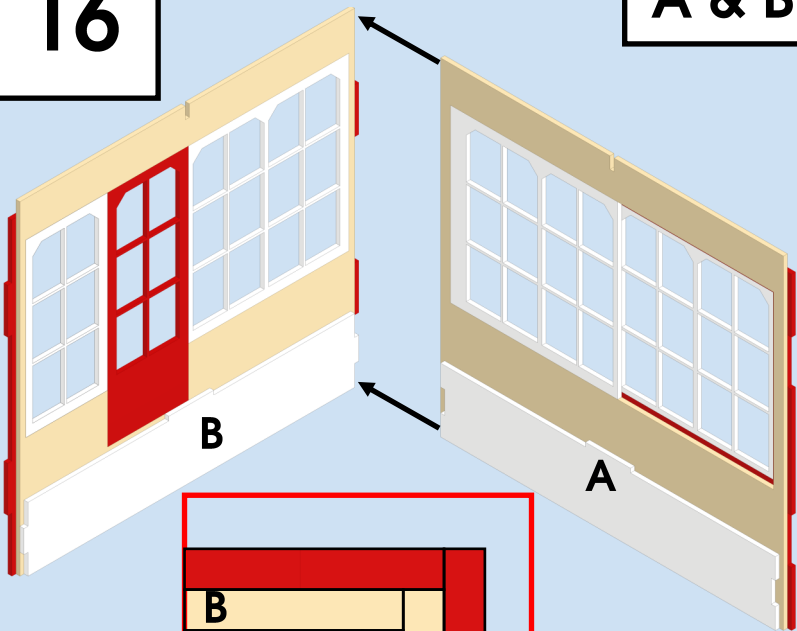

17

AB & C

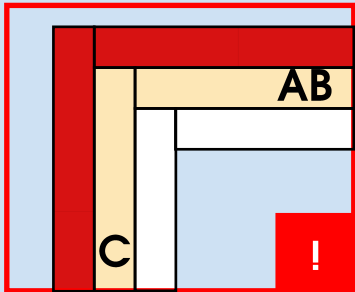
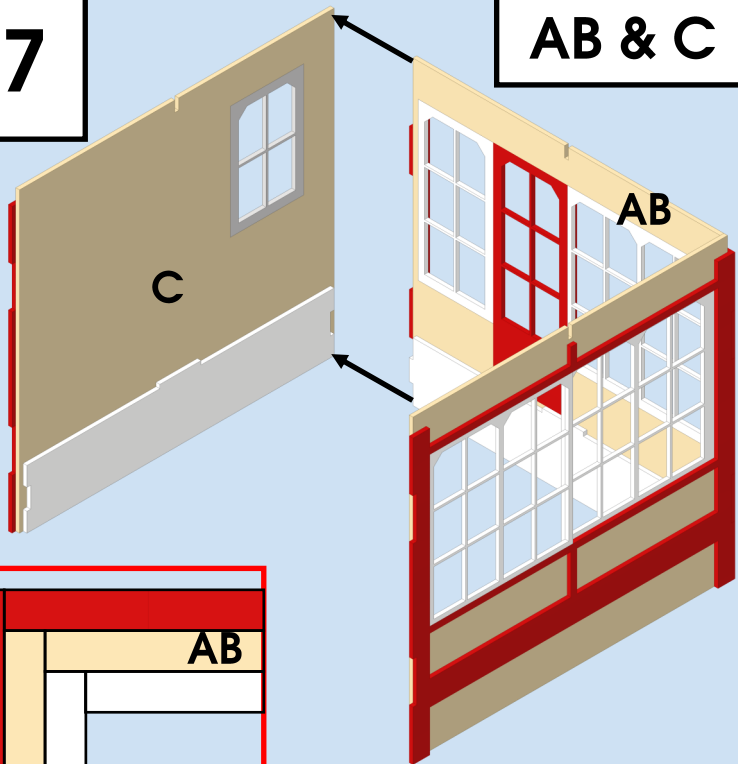

18

ABC & D

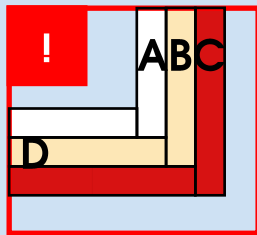
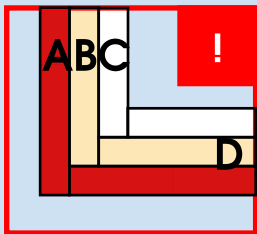
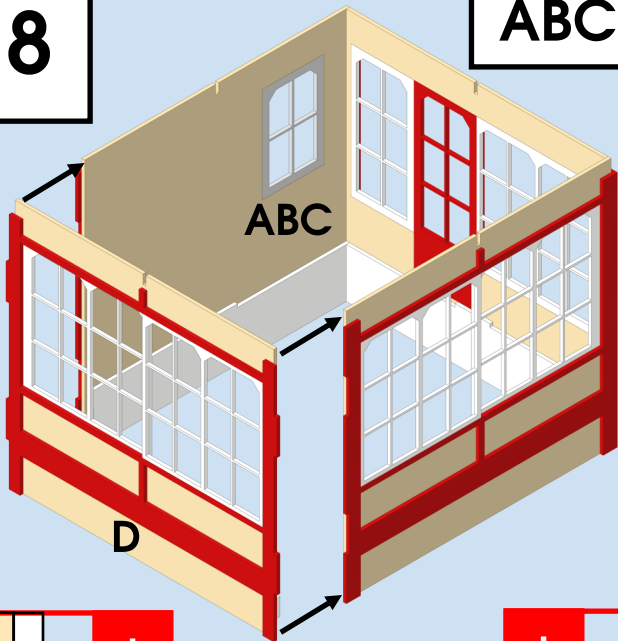

19

ABCD & G1

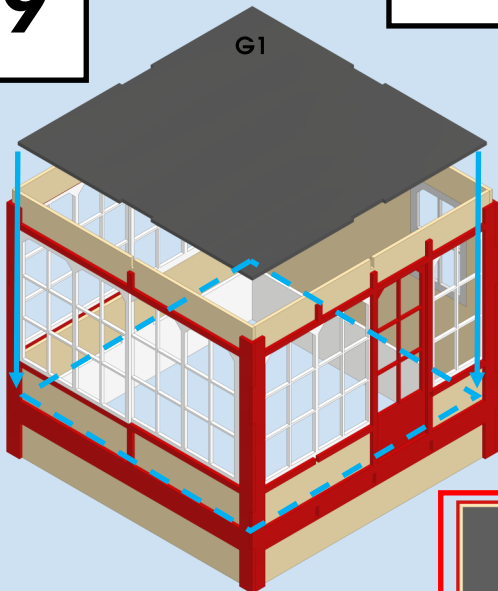

ABCD

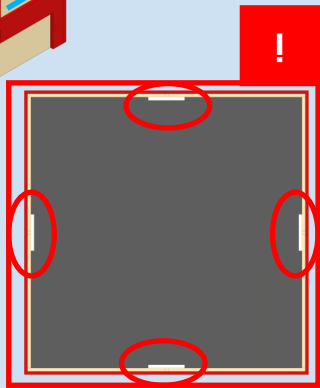

20

A4 (x2)

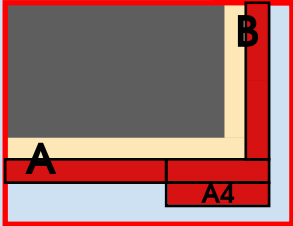
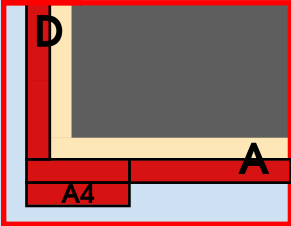
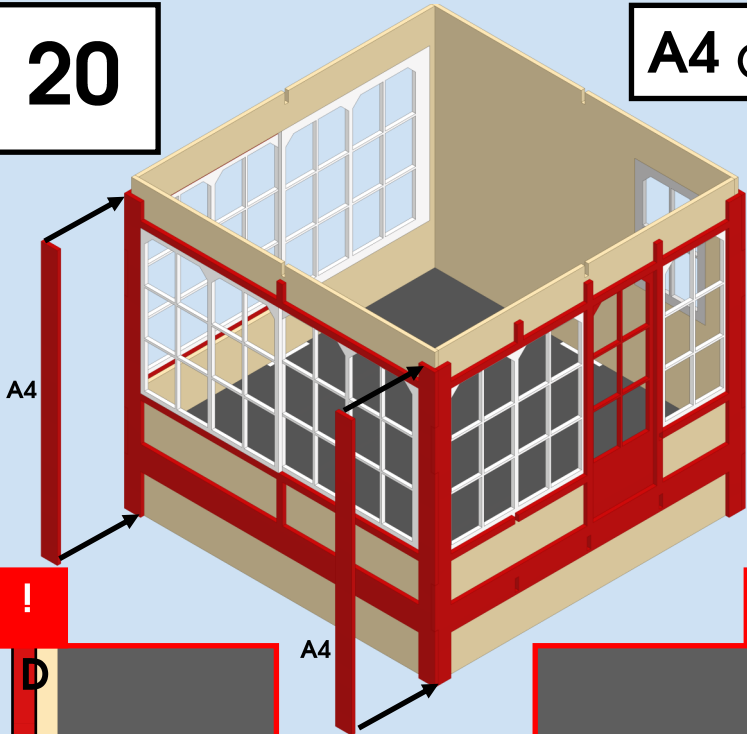

21

C4 (x2)

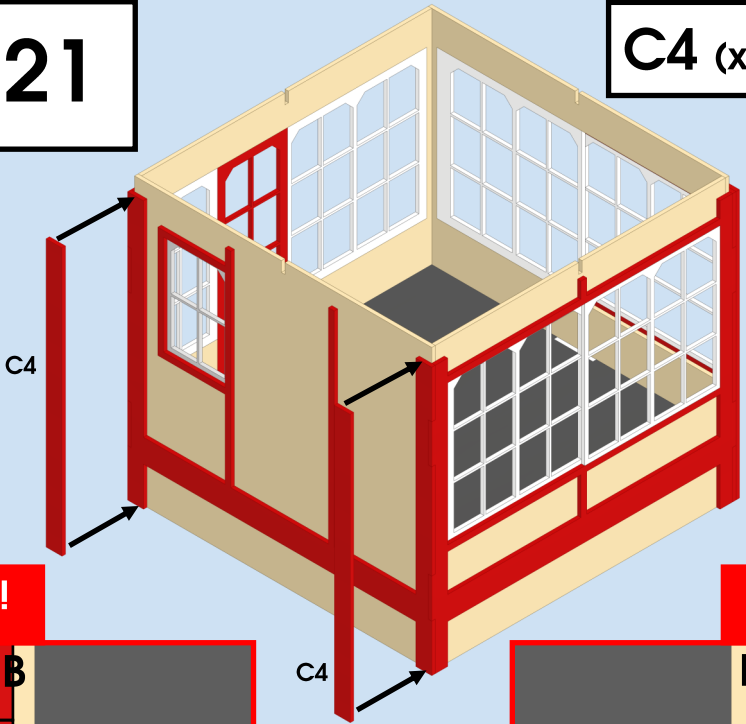

!

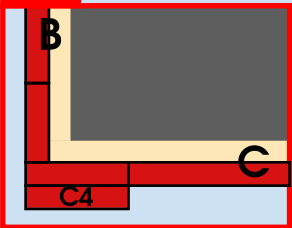

!

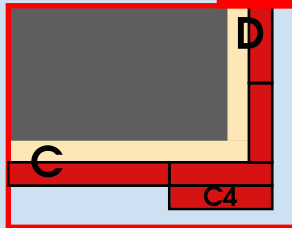

22

B4 (x2)

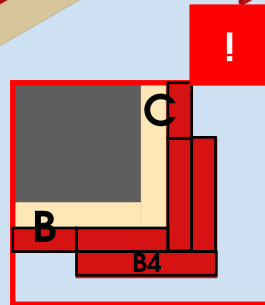
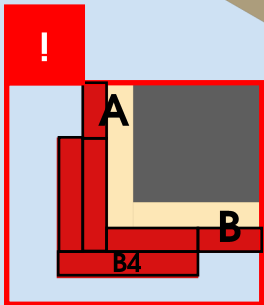
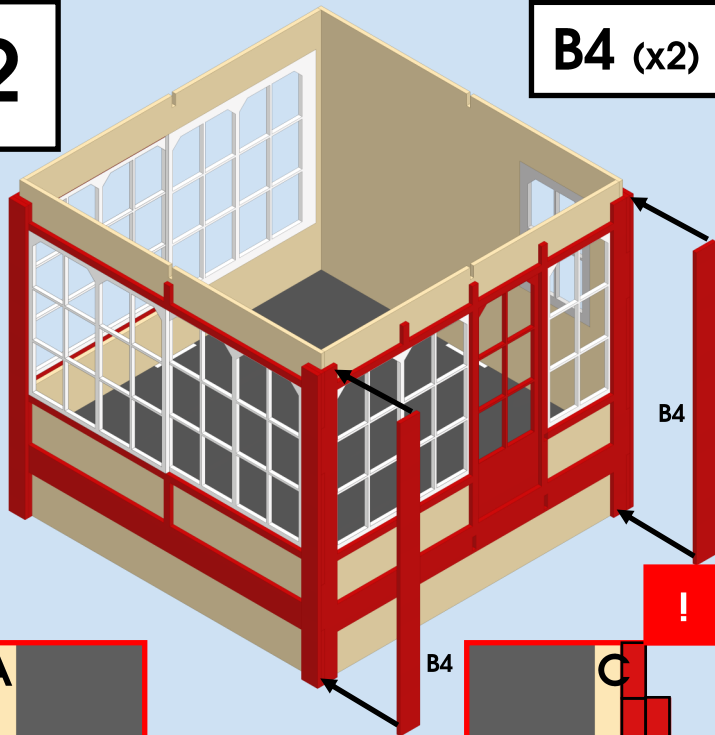

23

D4 & D5

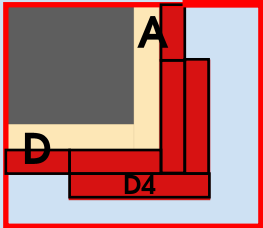
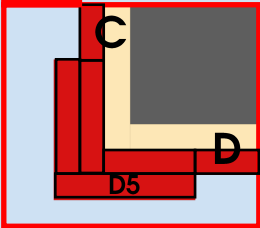
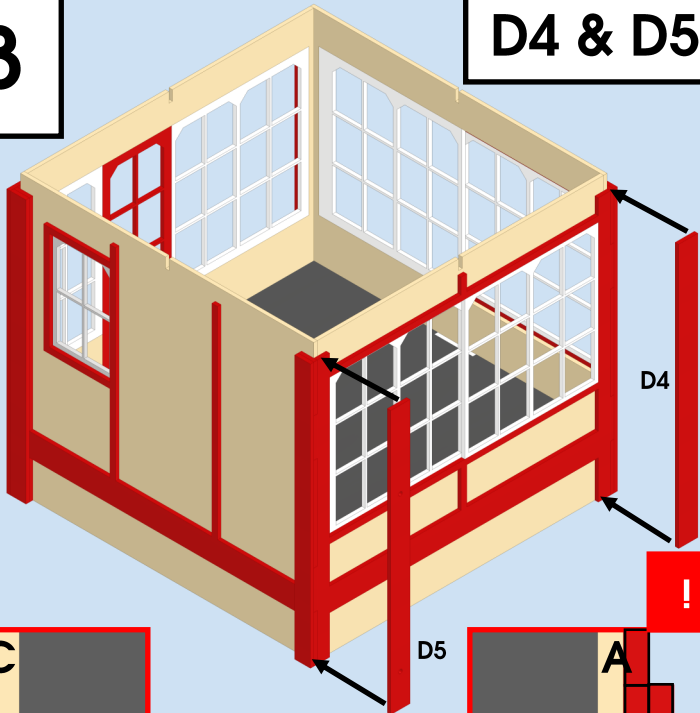

24

H1

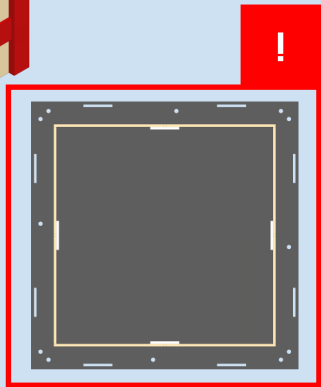
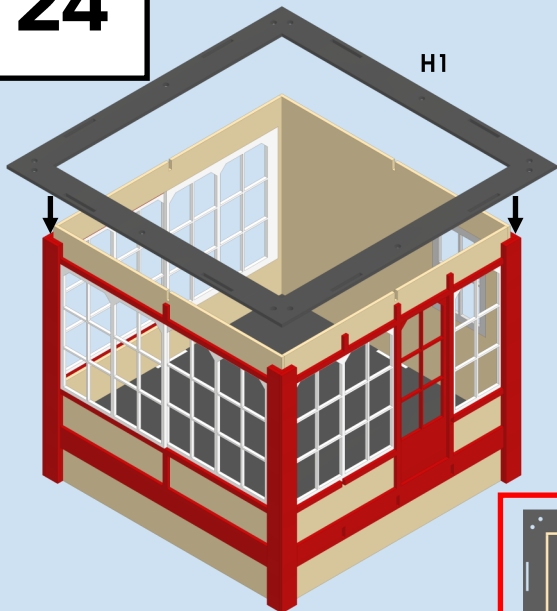

25

H3 & H4

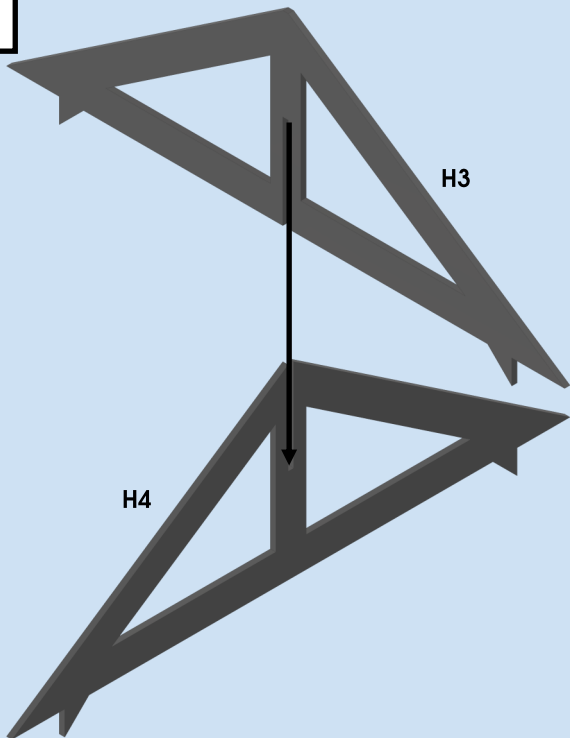

H3

H4

26

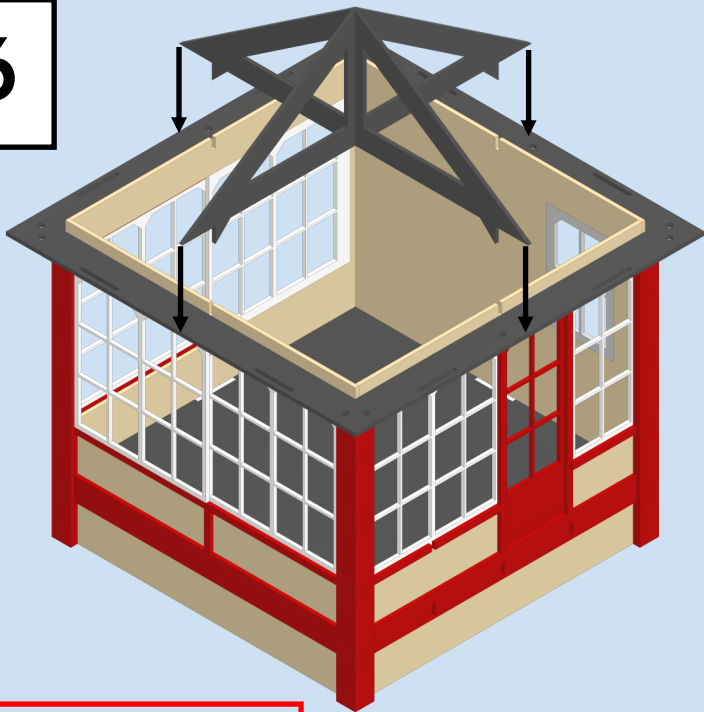

!

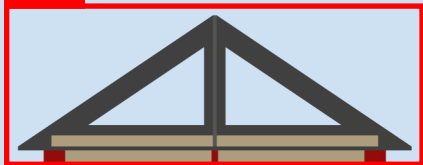

27

H5

H5

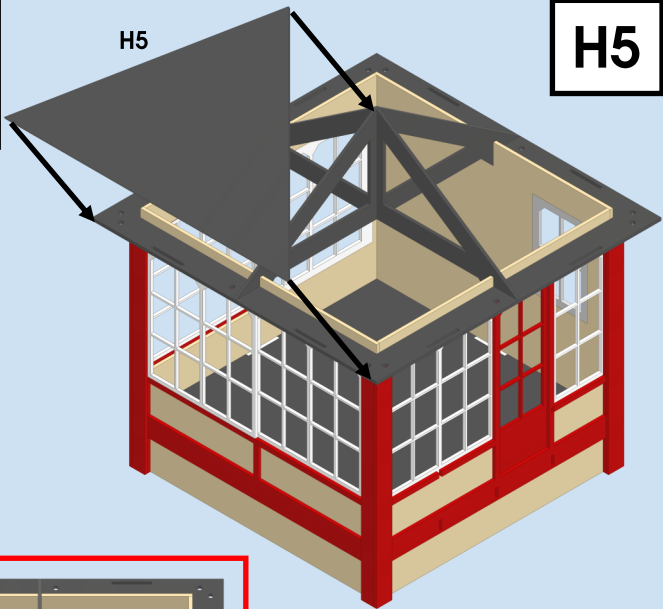

28

H5 (x2)

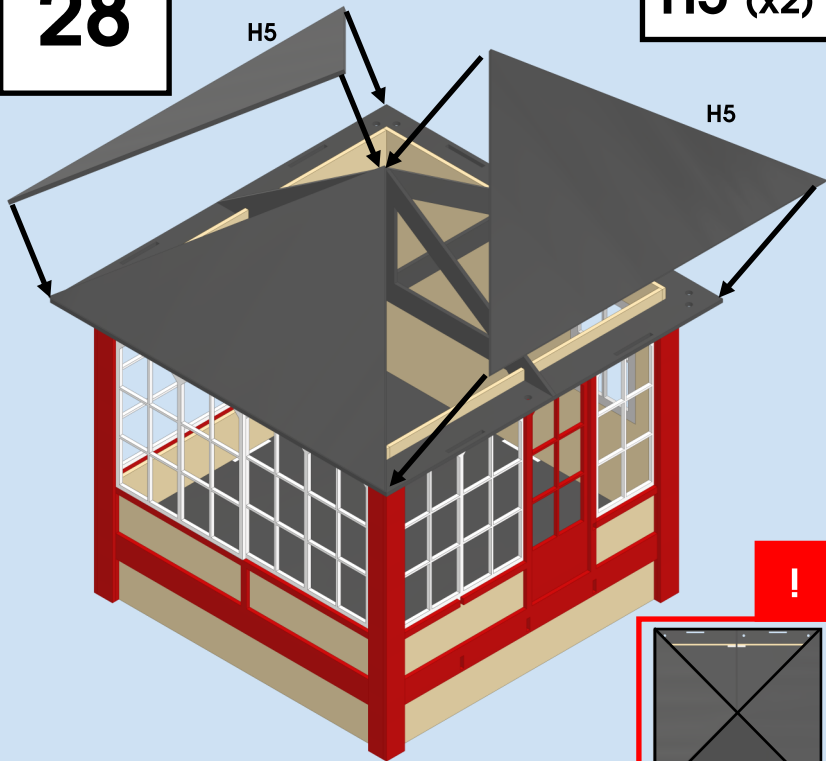

29

H5

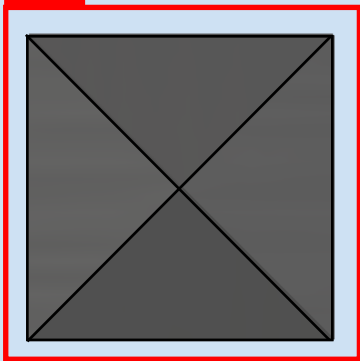
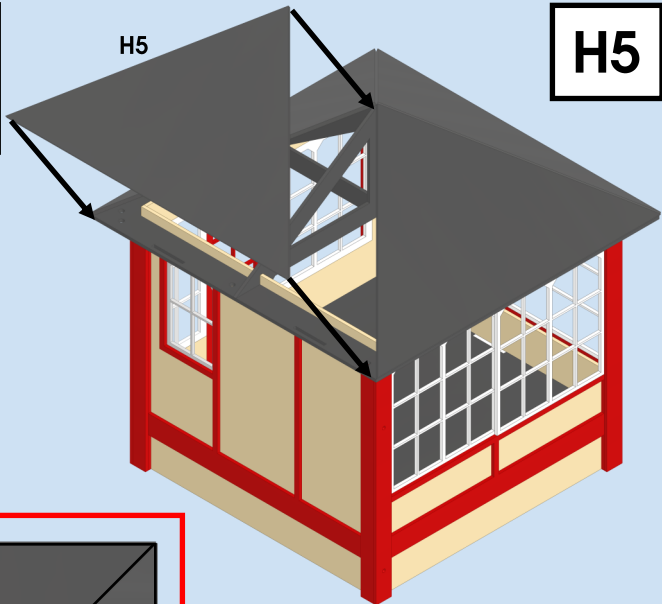

30

J2 (x2)

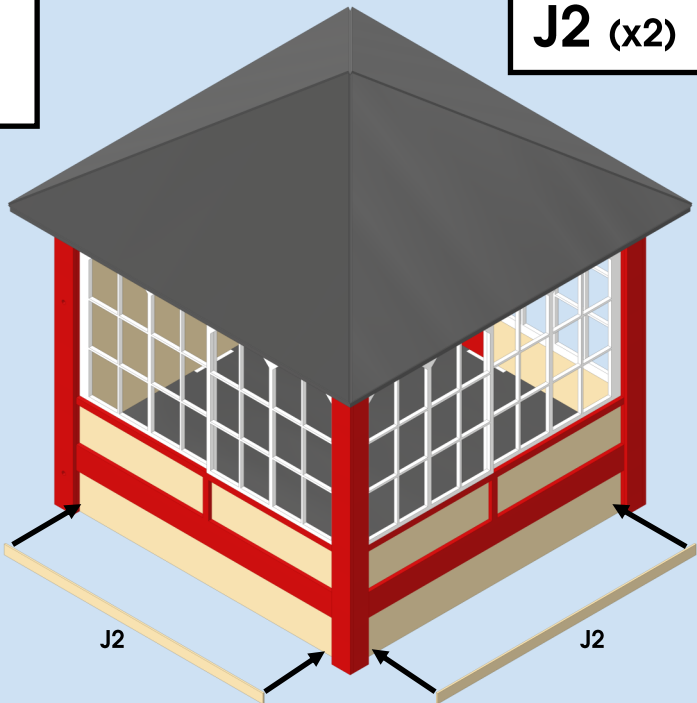

!

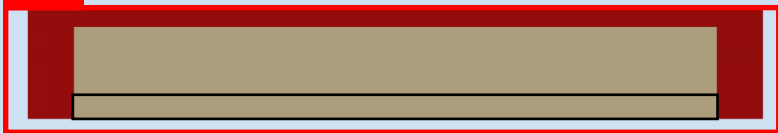

31

J1 (x6)

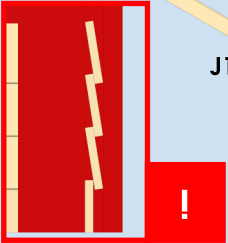
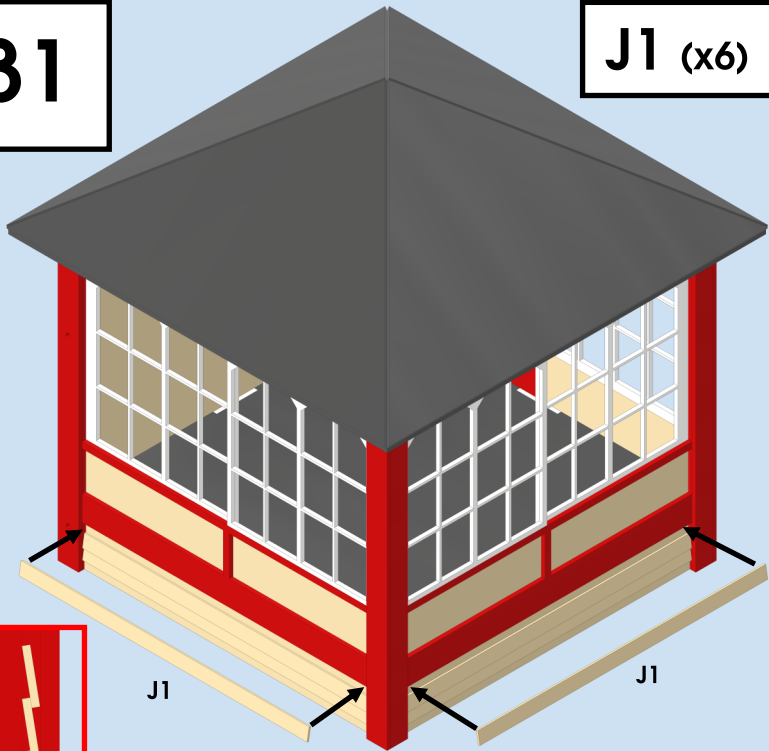

32

J2 (x2)

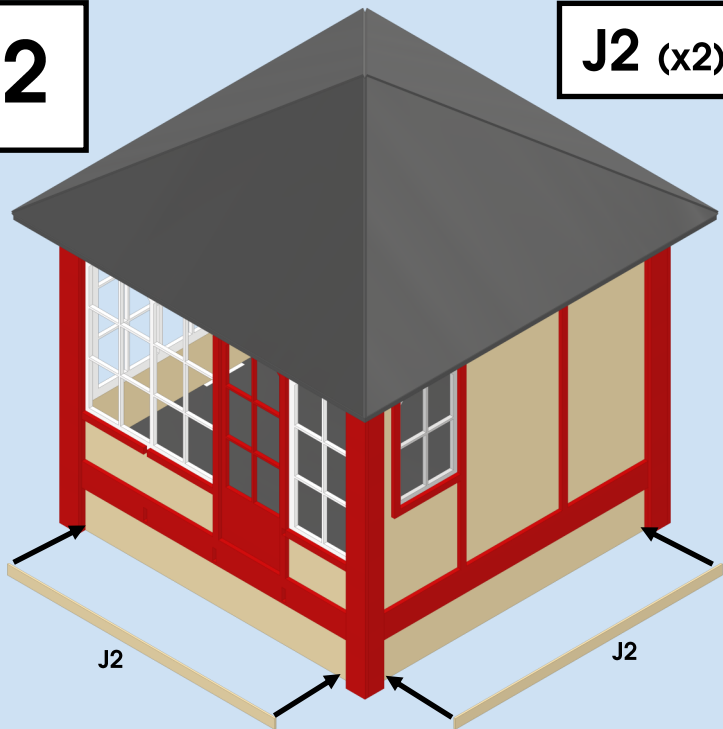

!



33

J1 (x6)

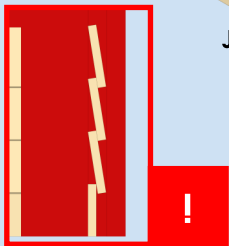
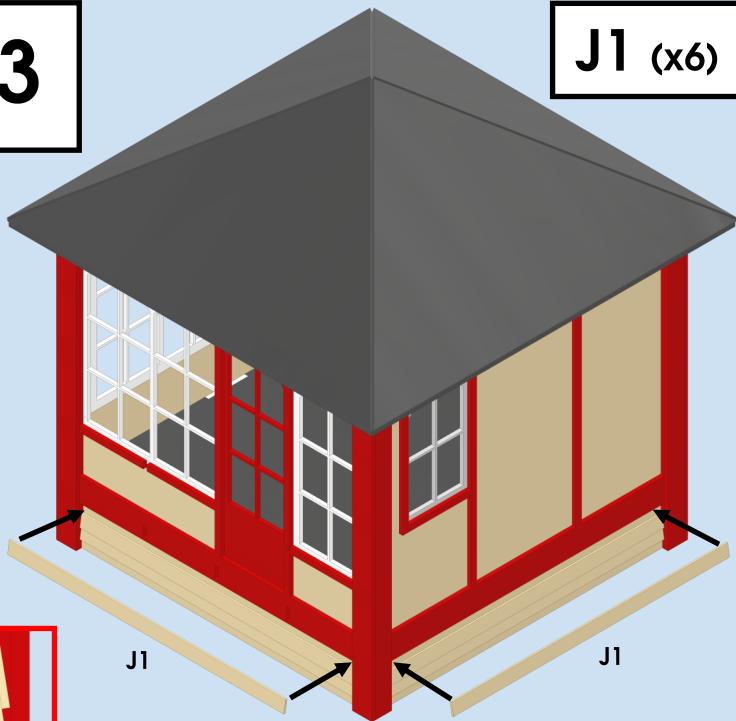

34

H2

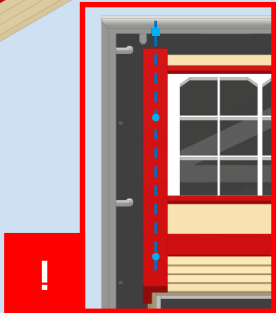
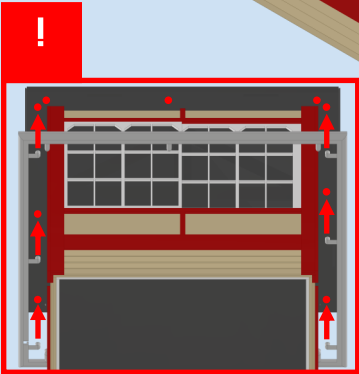
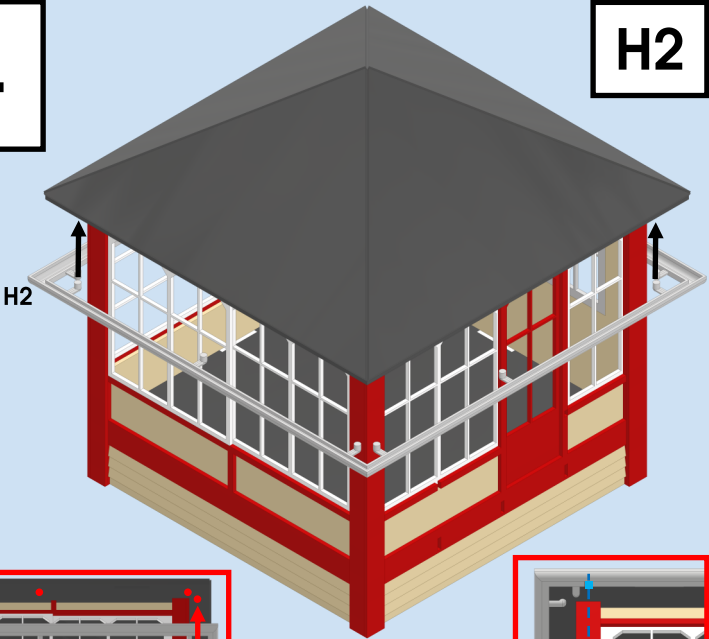

35

G3 (x2)

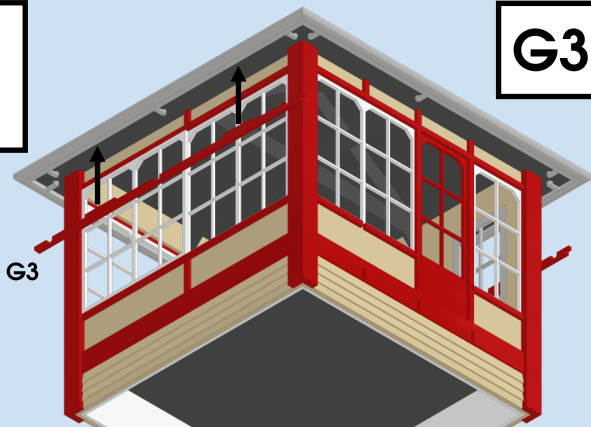

36

G2 (x2)

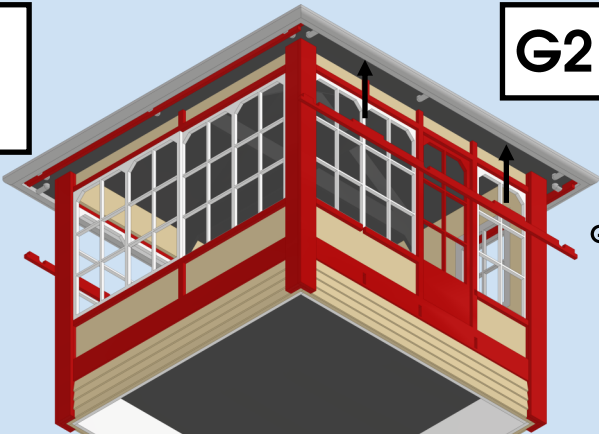

G2



G2

37

H8

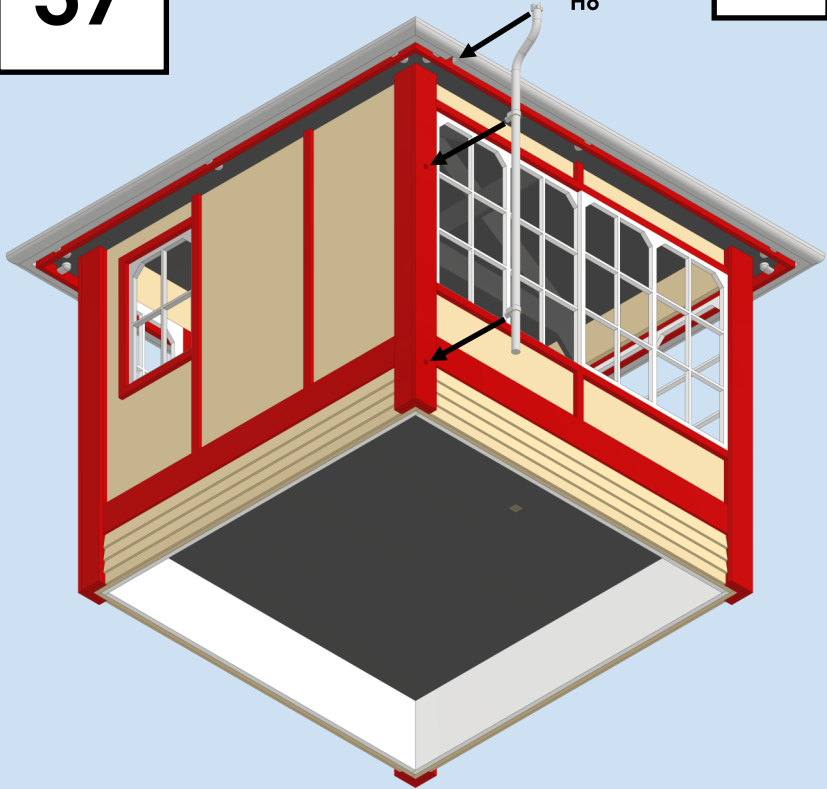

38

Tiles

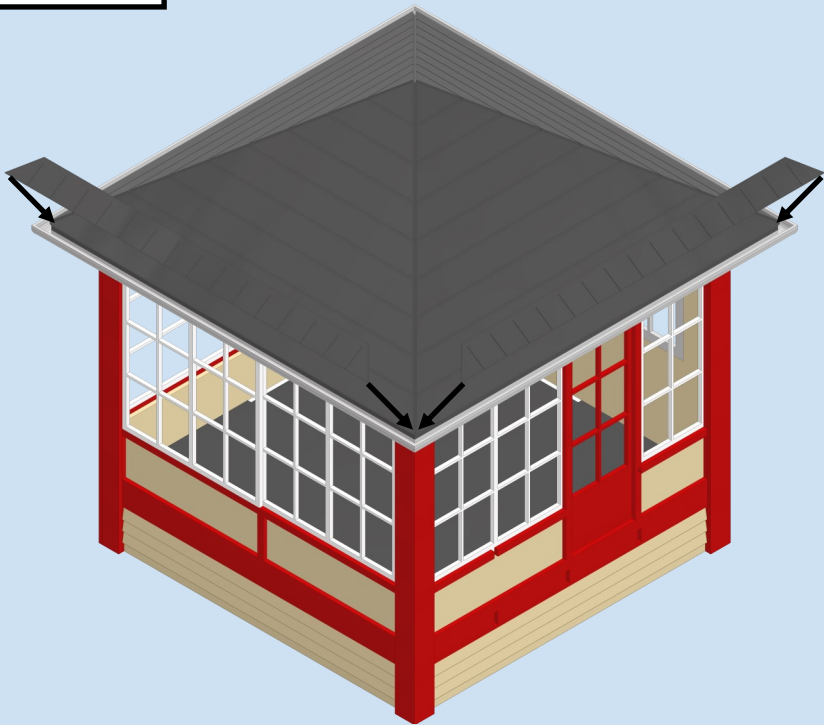

39

Tiles

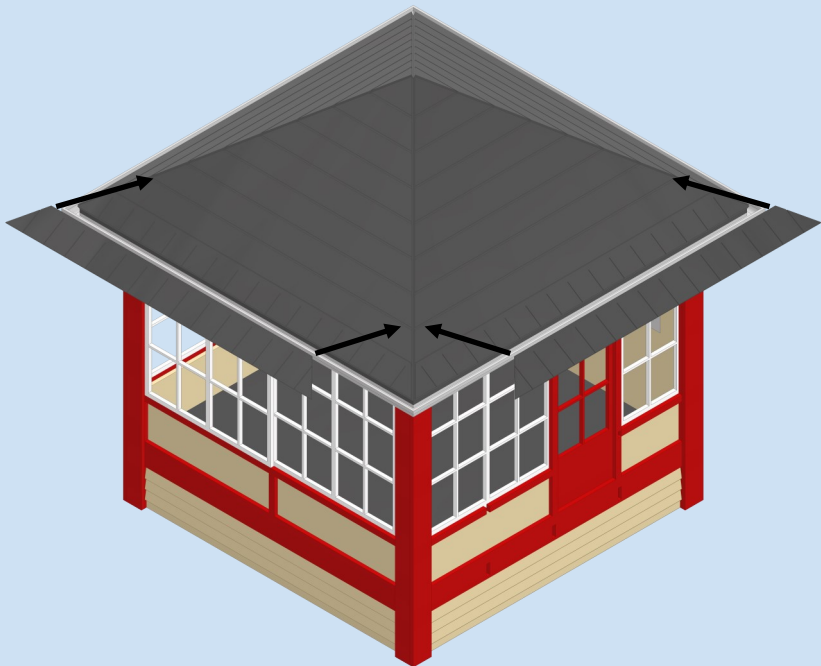

40

Tiles

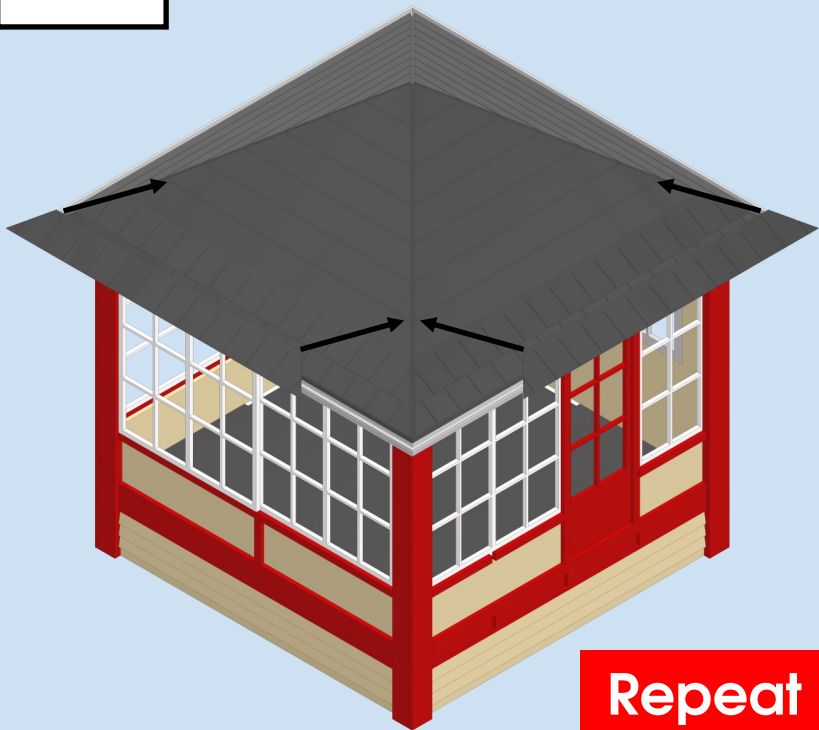

Repeat

41

Tiles

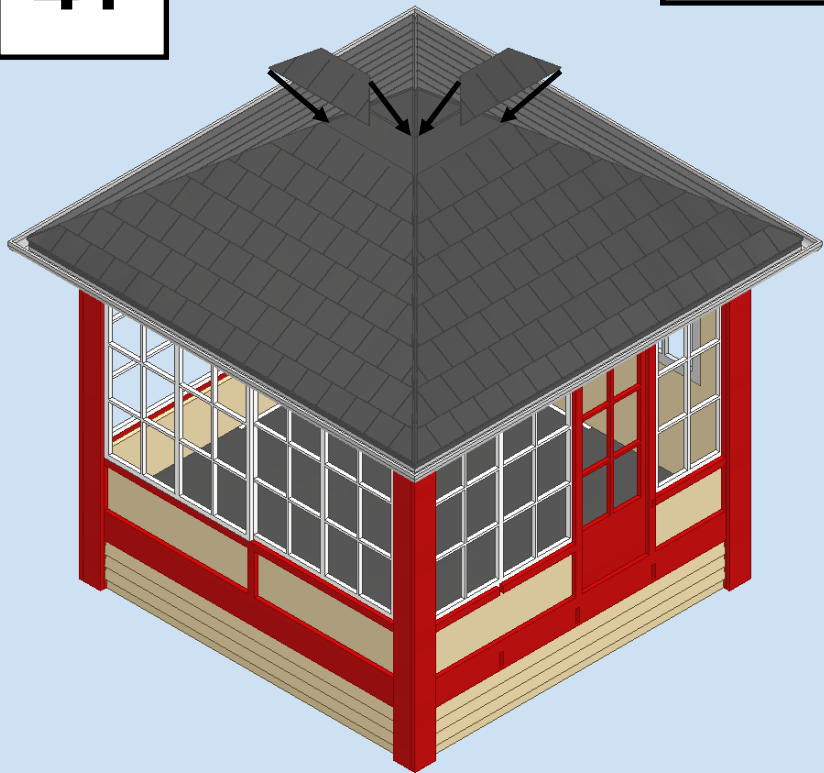

42

Tiles

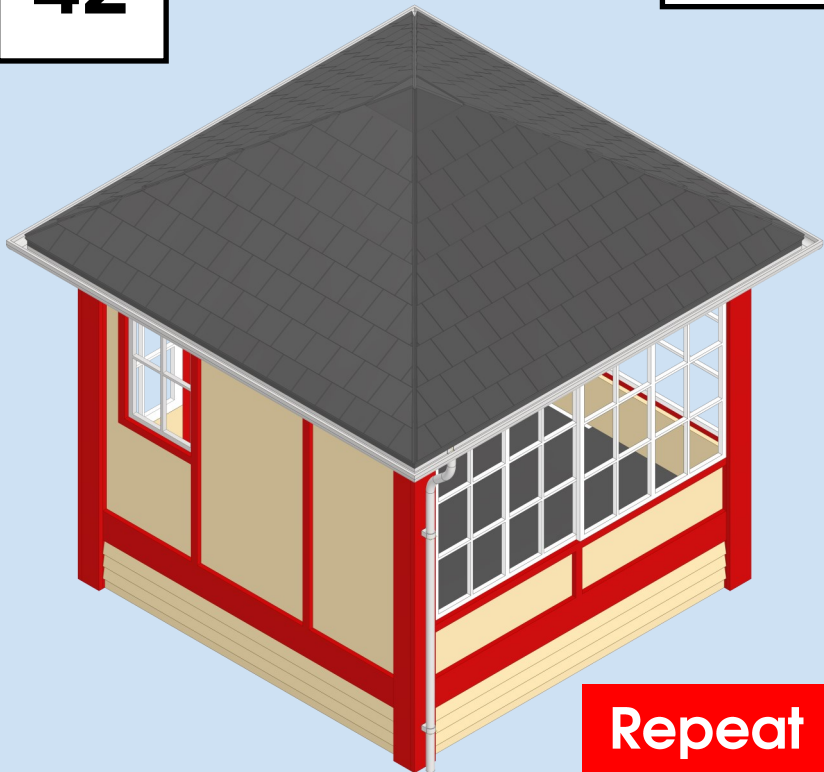

Repeat

43

H6

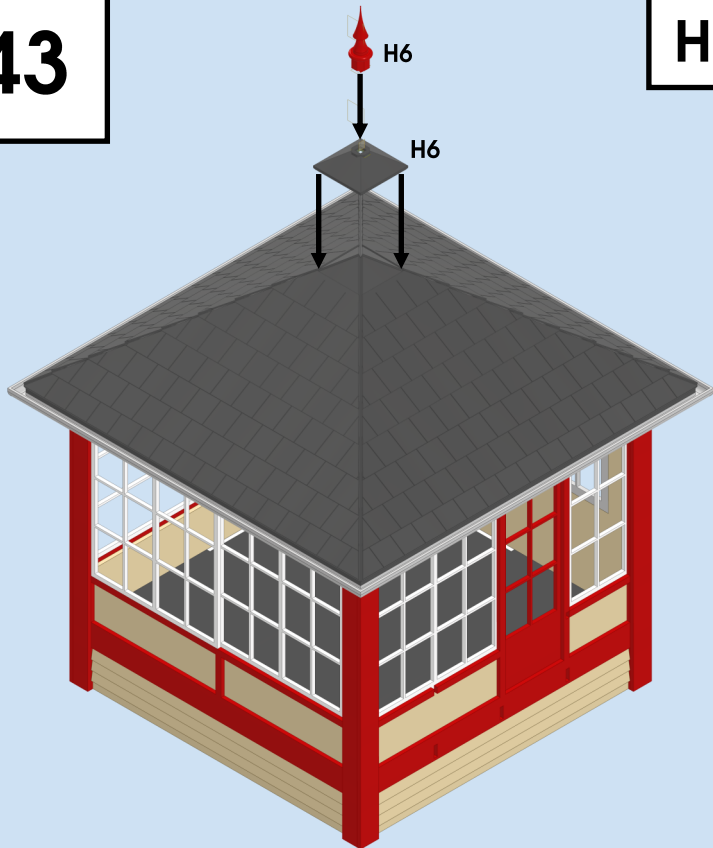

44

H9 (x2)

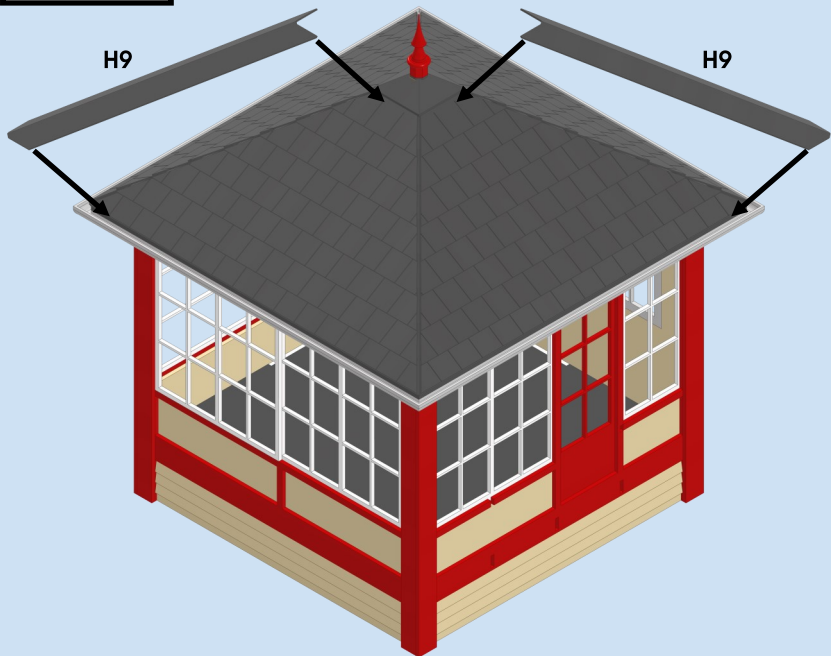

45

H9 (x2)

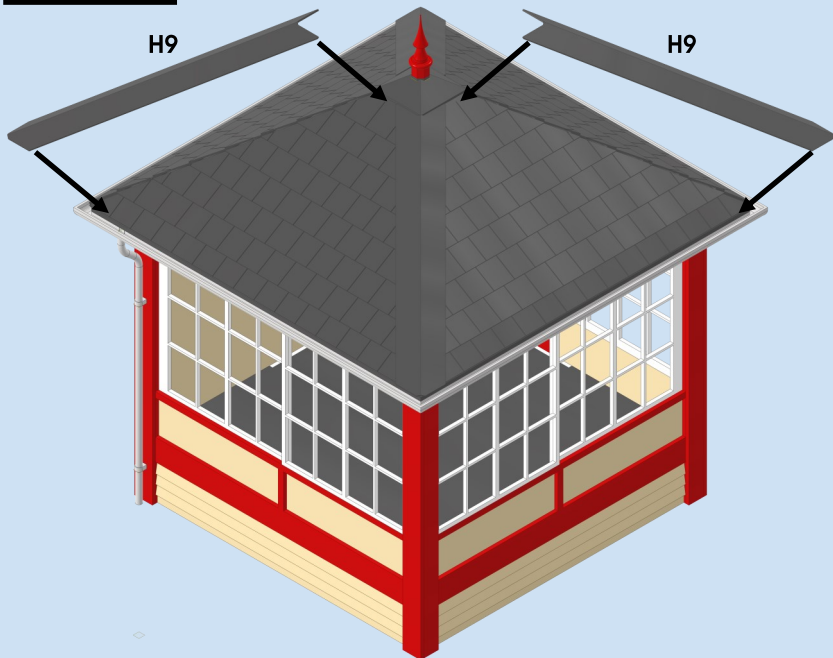

46

F4 & F5

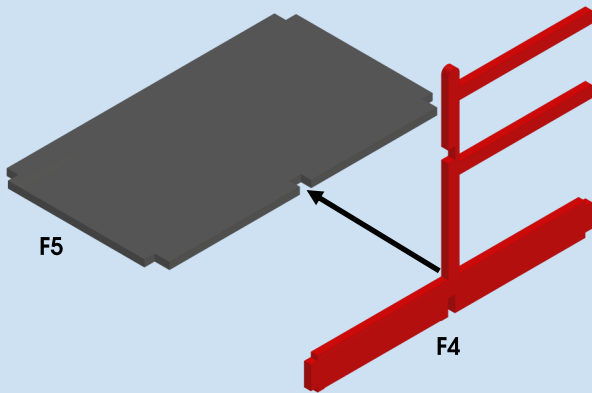

47

F & F2

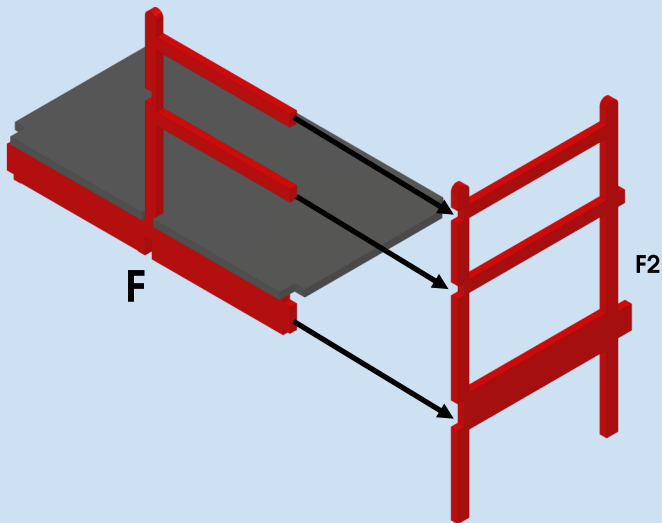

48

F & F3

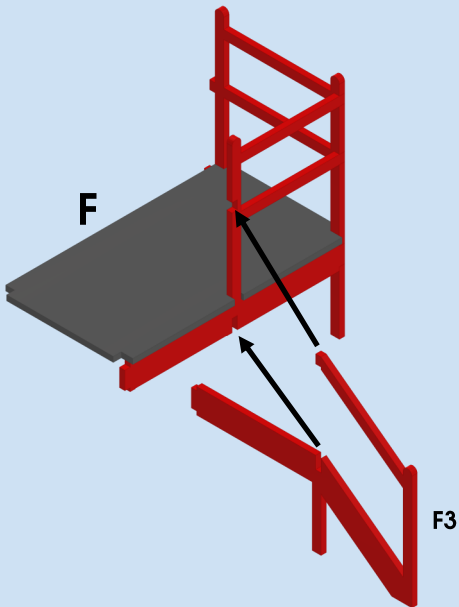

49

F & F6

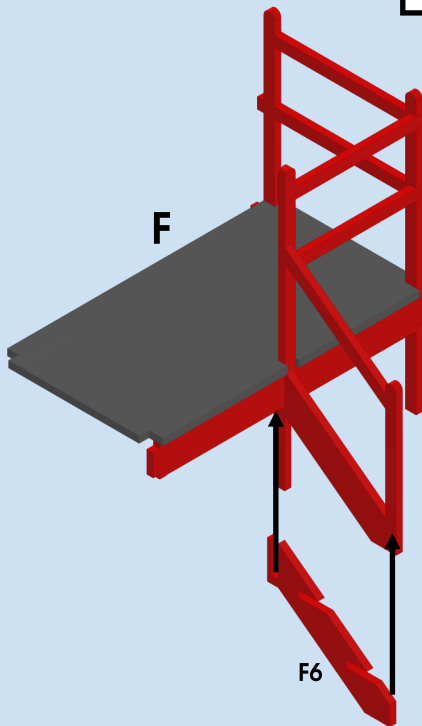

50

F & F1

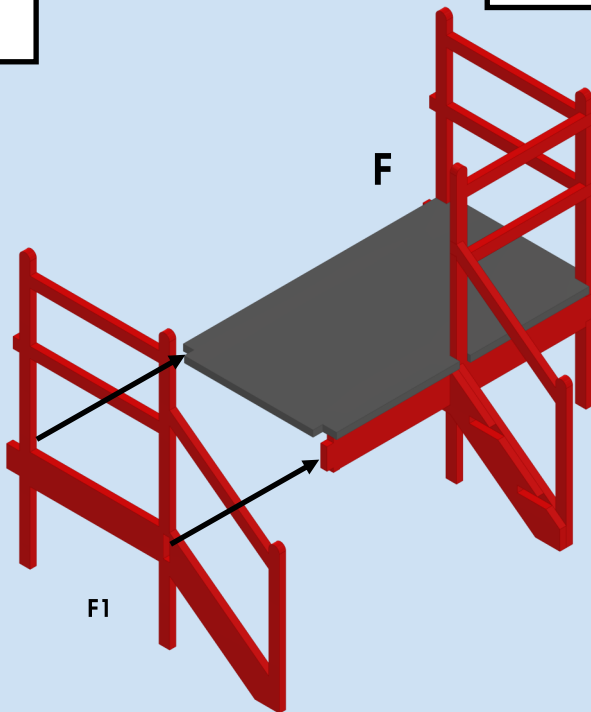

51

F & F6

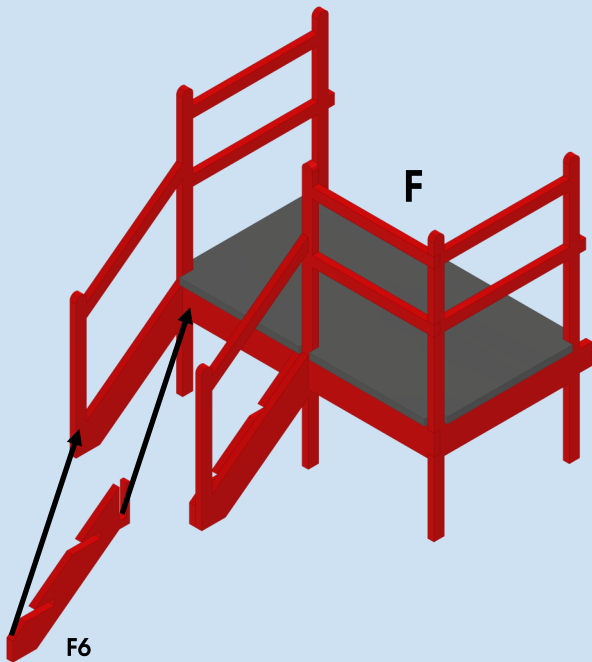

52

F & F7 (x2)

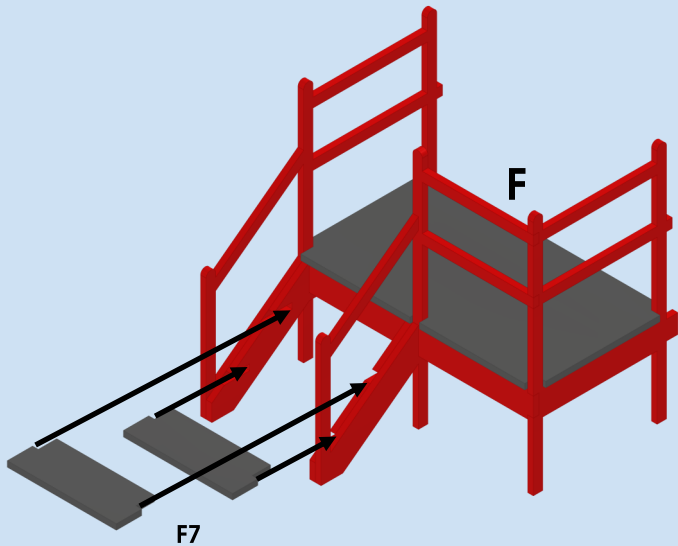

53

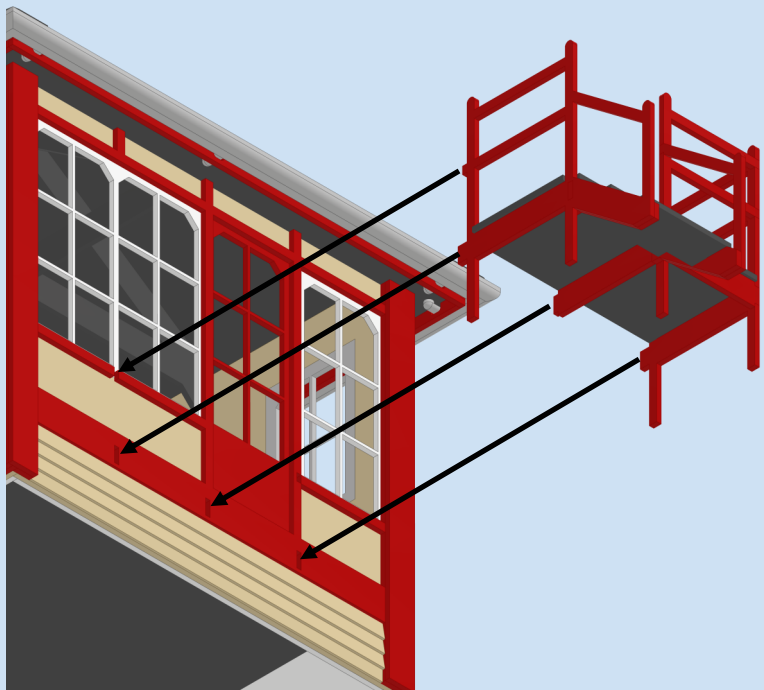

F

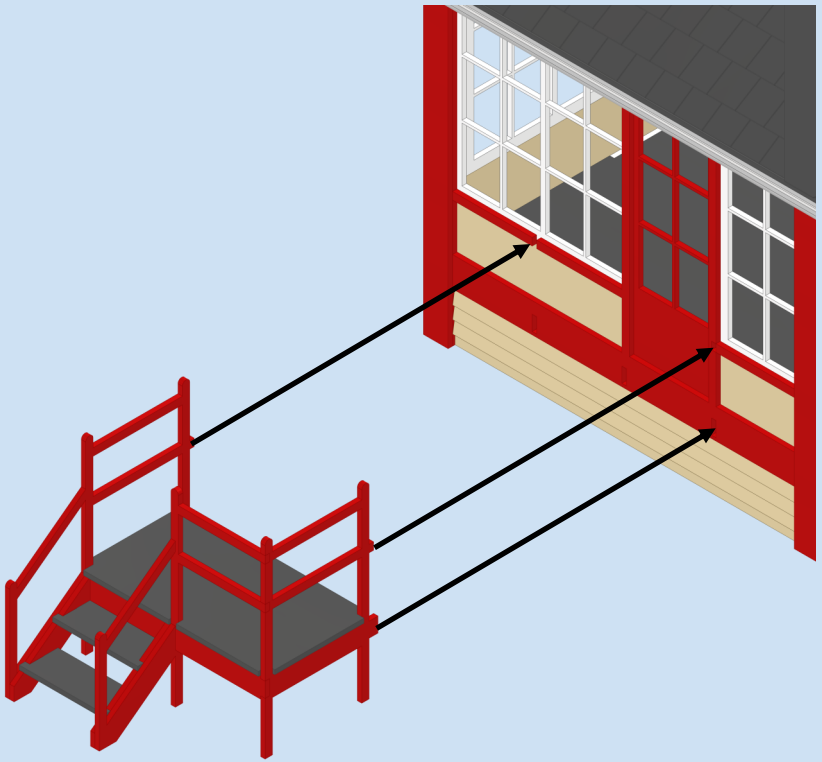

54

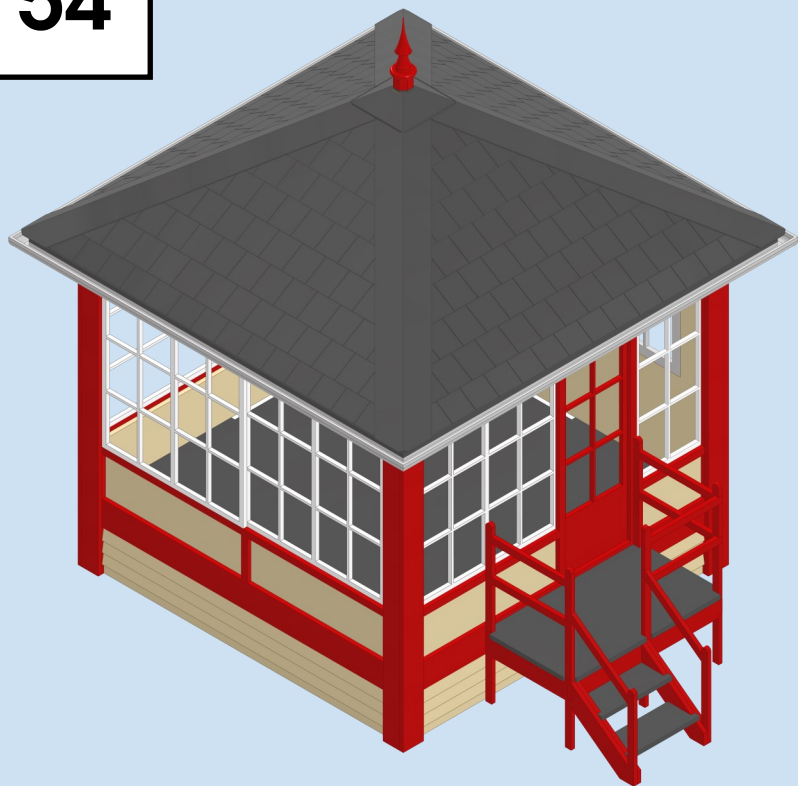

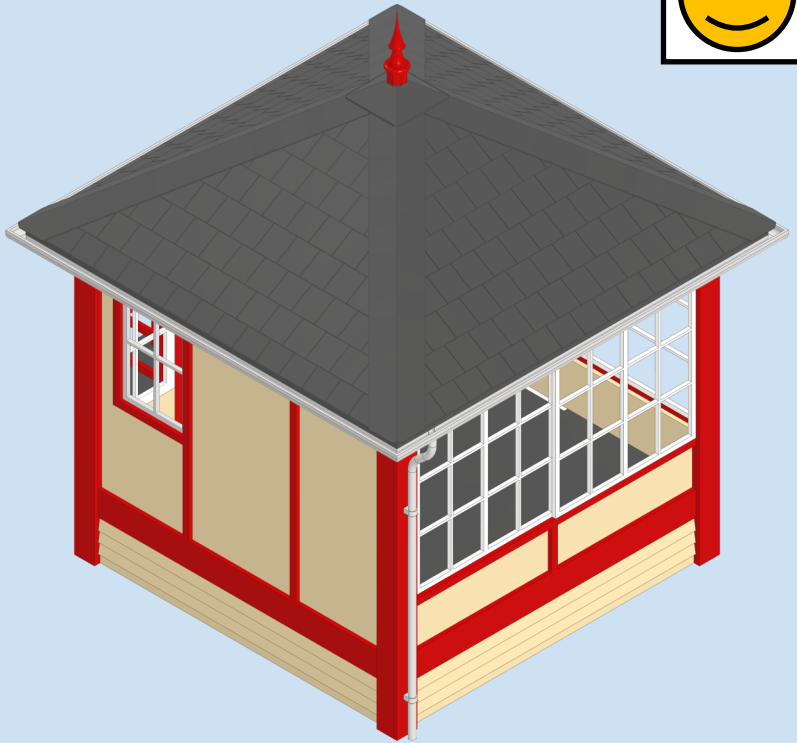

The logo for 'dapol' is centered on a blue background. The word 'dapol' is written in a lowercase, italicized, sans-serif font. It is enclosed within a thin, light gray rectangular border that follows the slant of the text. The background is a solid blue color, with a white curved line on the left side separating it from a gray area.

dapol