

dapol

Gauge



7B-001-004

Midland Railway Yard Office

Based on Oakworth, K&WVR

 **Kitmaster** 
TRADE MARK
GENESIS

Read Before Building

Estimated Build Time:
3-4 hours

This is a very complex kit, we strongly recommend taking your time building it. It is also very important to keep a clean work area as the card is permeable and can stain very easily.

We recommend using a standard PVA glue slightly diluted with water. We do not recommend any fast drying glues, as they can dry too quickly, making any small positional adjustments difficult. It's best to apply the glue using a small paintbrush or cardboard offcut.

Parts cannot be bought individually. Spare or replacement frets can be bought £10 each for large frets and £7 each for small frets by contacting sales@dapol.co.uk

Printed instructions are available free of charge by contacting sales@dapol.co.uk

But most of all. Enjoy.

Checklist

- Clear
 - (x2)
 -
- Slate 1
 - F1 (x2)
- Slate 2
 - B6
 - F8 (x4)
- Slate Thin 1
 - F9
 - F10 (x4)
 - F11 (x4)
 - F17
- Slate Thin 2
 - F9
 - F10
 - F11 (x2)
 - F12
 - F13
 - F14
 - F15
 - F16
- Stone 1
 - A1
 - A3
- A4
- A5 (x2)
- A6 (x2)
- Stone 2
 - A6
 - B1
 - B3 (x2)
 - B4(x2)
 - B5(x2)
- Stone 3
 - A6
 - C1
 - C3
 - C4
- Stone 4
 - D1
 - D3 (x2)
 - D5 (x2)
 - D6 (x2)
 - D7
 - F2
 - F3
 - F4
 - F5
 - F6 (x2)
- F7
- White 1
 - A2
- White 2
 - B2
- White 3
 - C2
- White 4
 - D2
- White 5
 - A7 (x2)
 - D4

1

A1 & A2

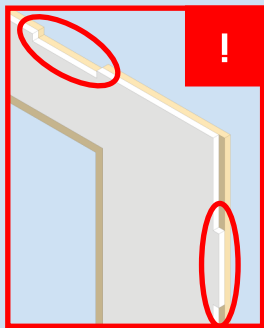
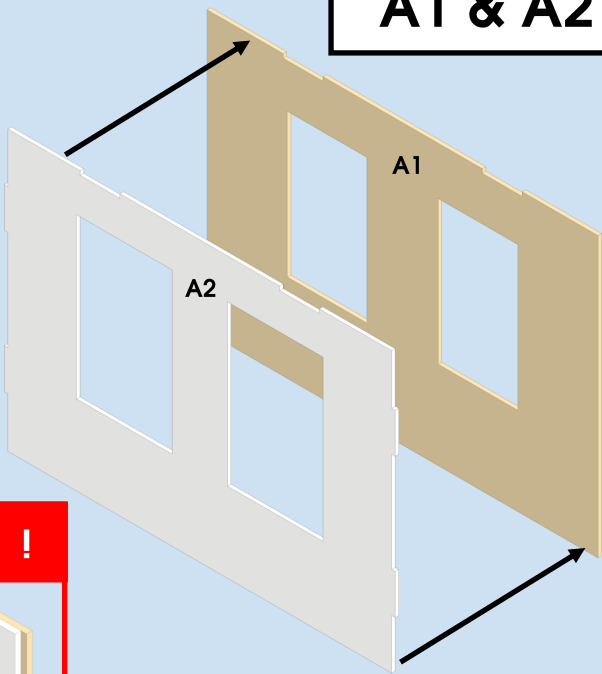

2

■ , A6_(x2) & A7

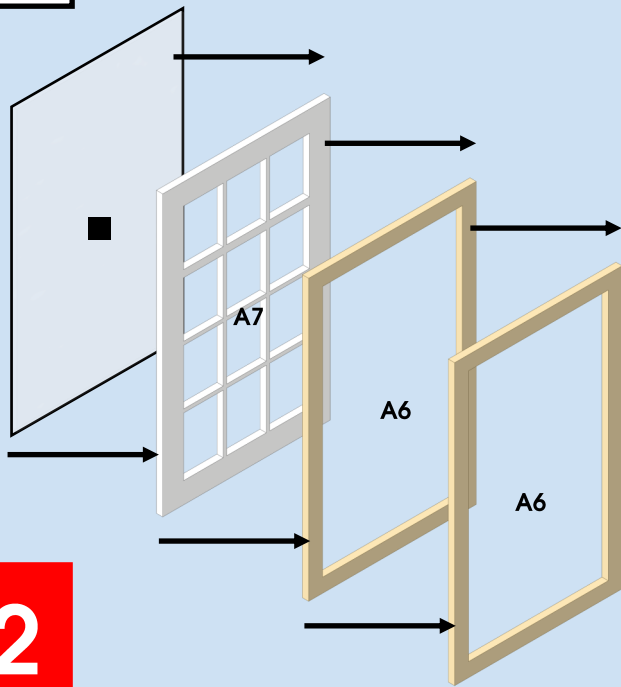

X2

3

A

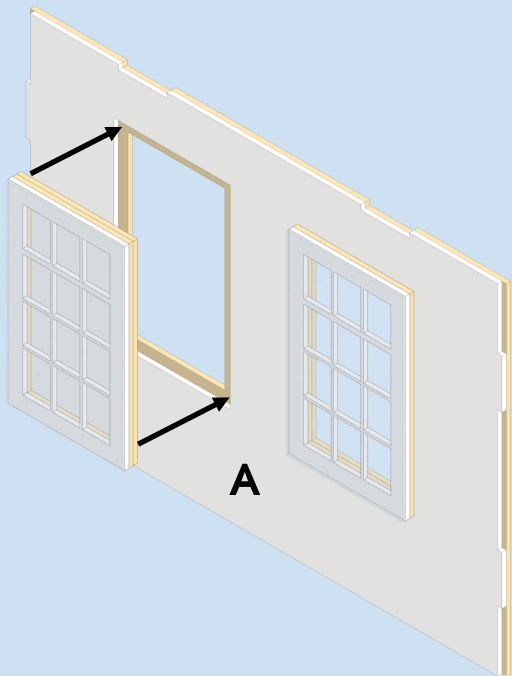

4

B1 & B2

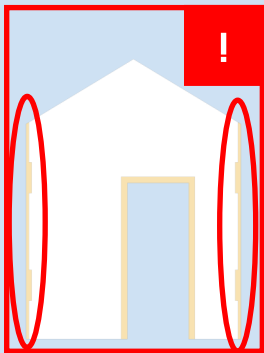
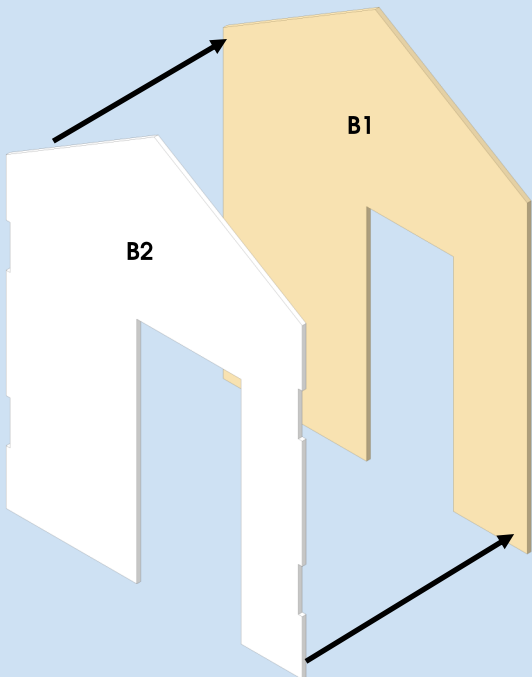

5

B5_(x2) & B6

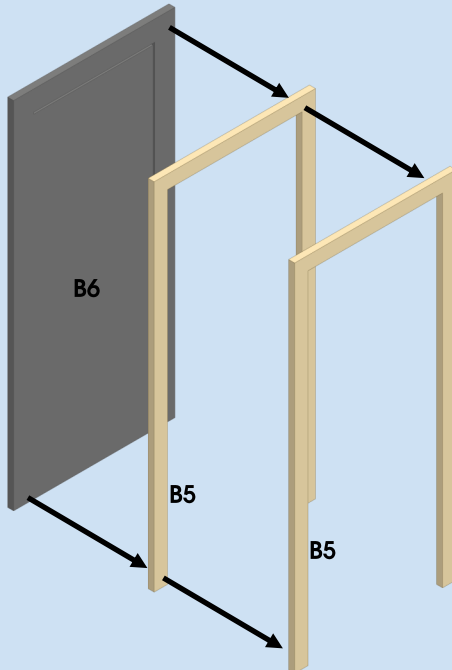

6

B

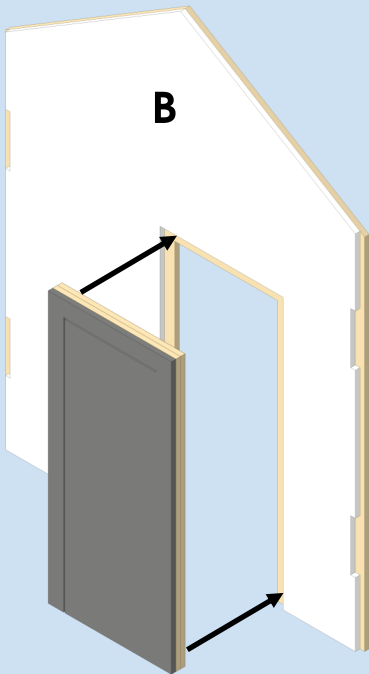

7

C1 & C2

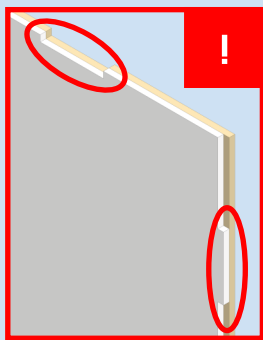
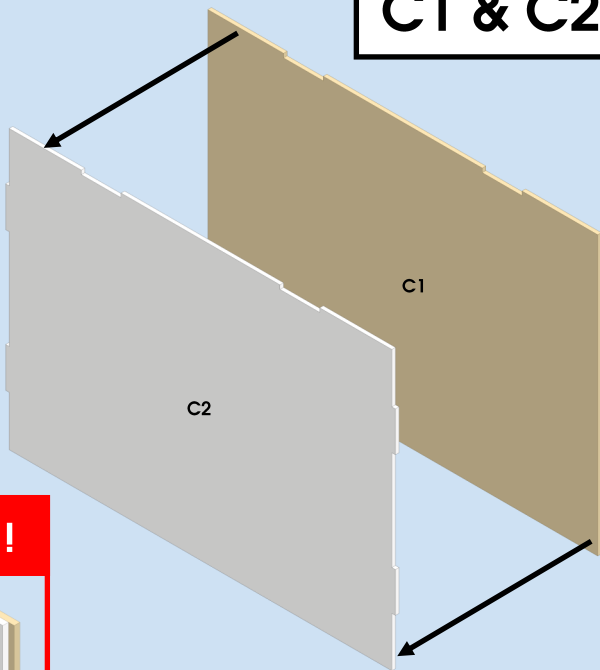

8

D1 & D2

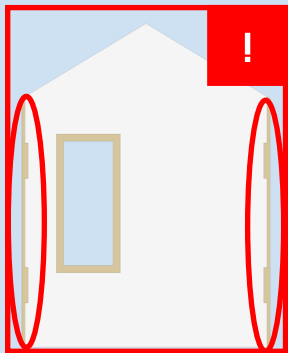
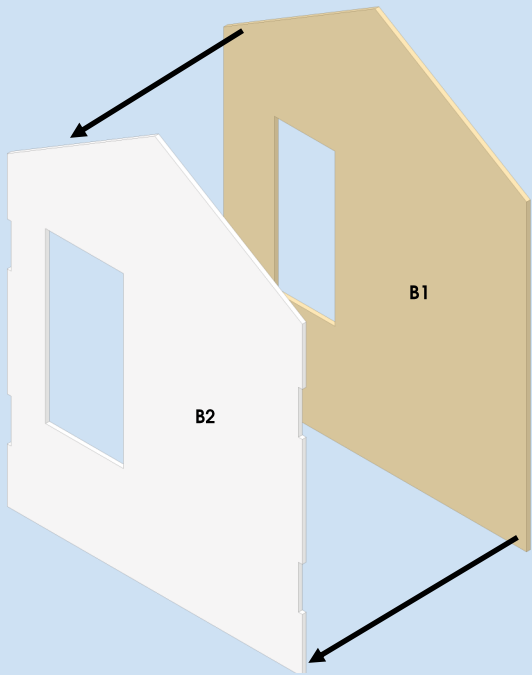

9

●, D3(x2) & D4

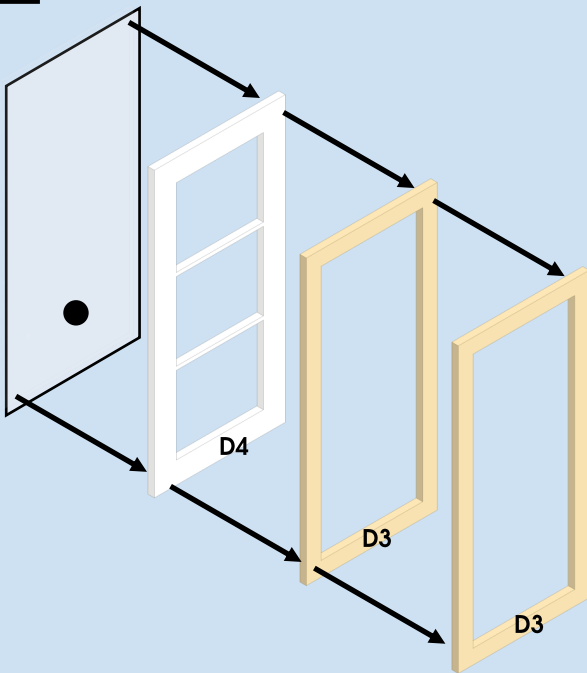

10

D

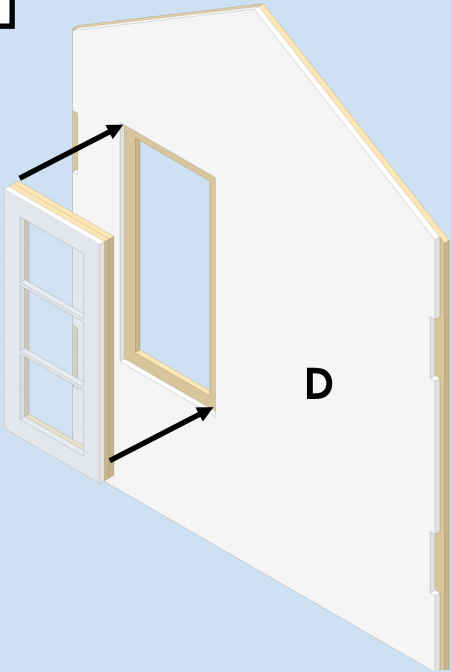

11

A & B

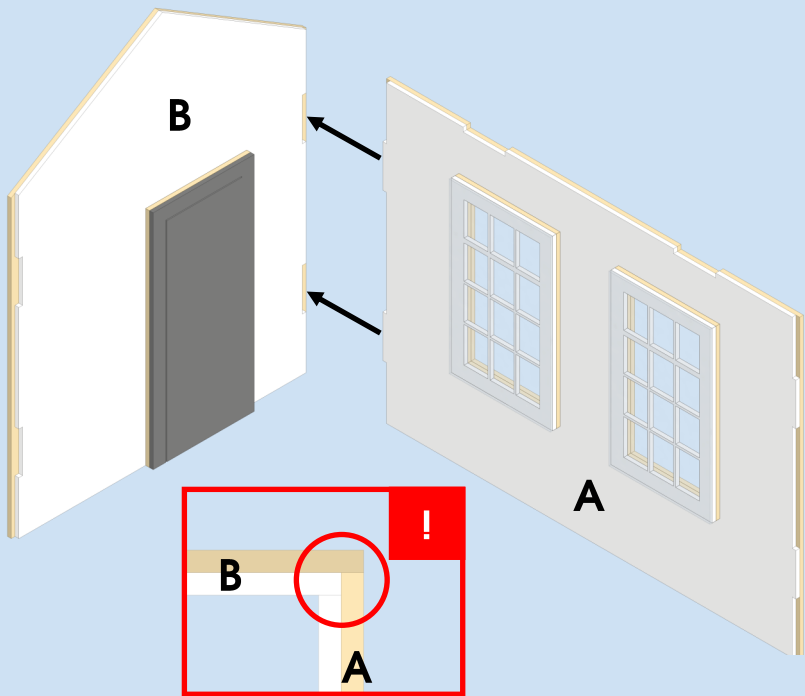

12

AB & C

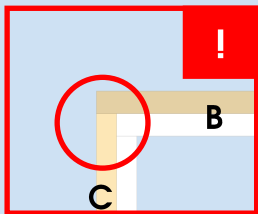
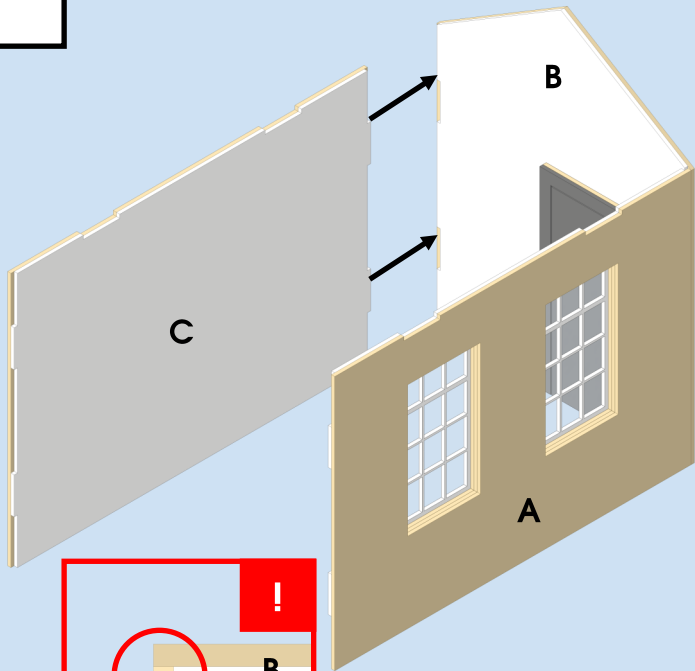

13

ABC & D

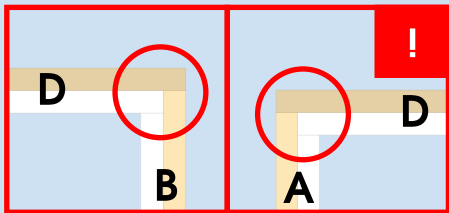
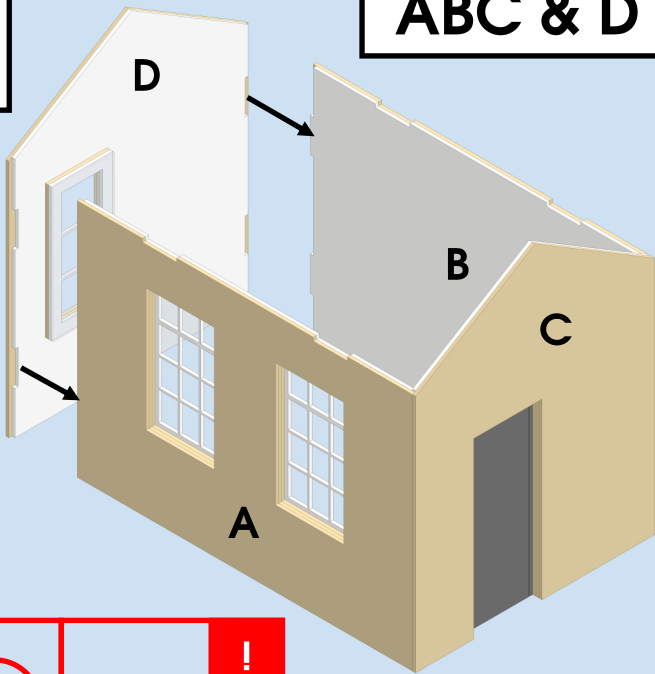

14

G1 (x2)

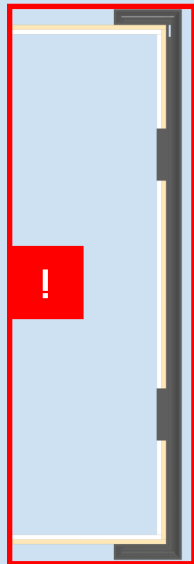
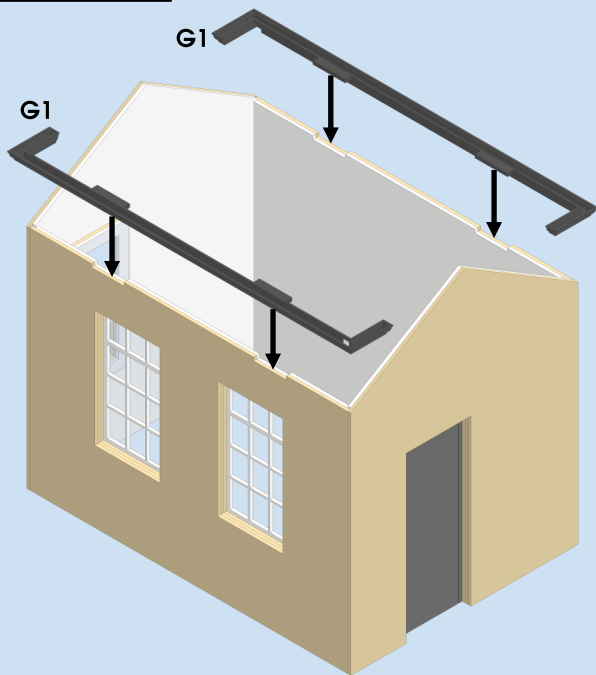

15

G2

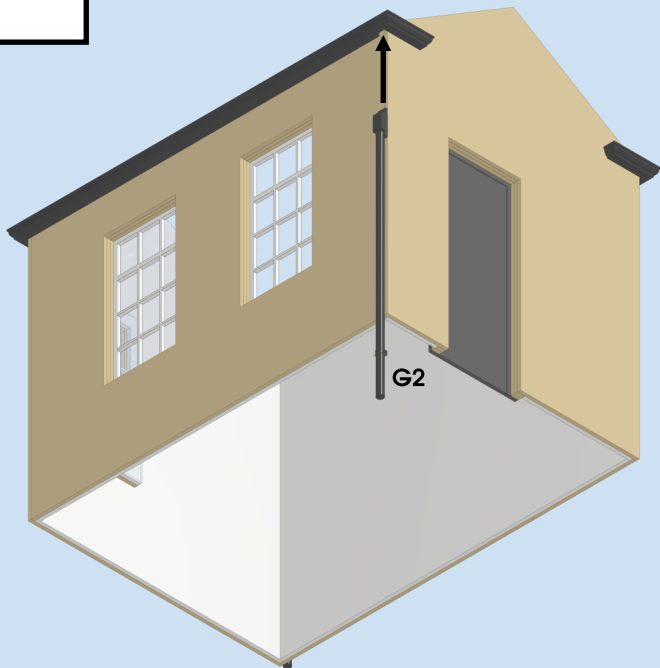

16

G2

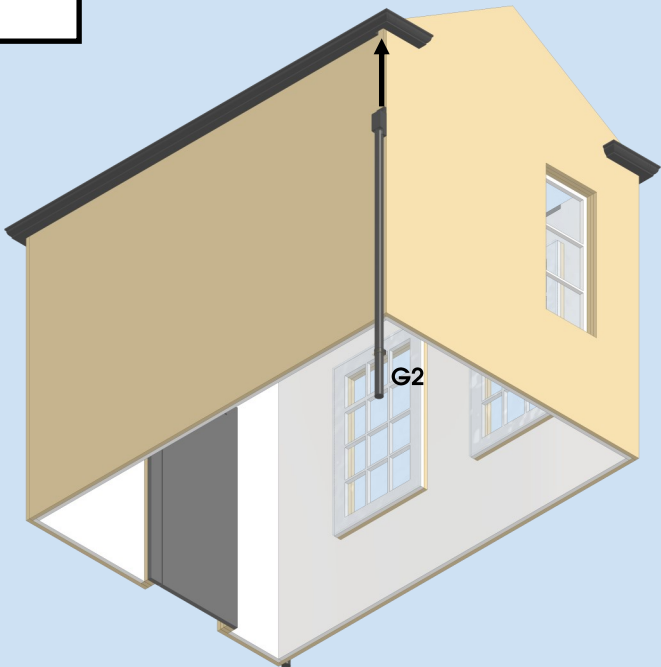

17

A3

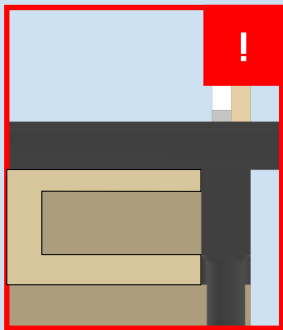
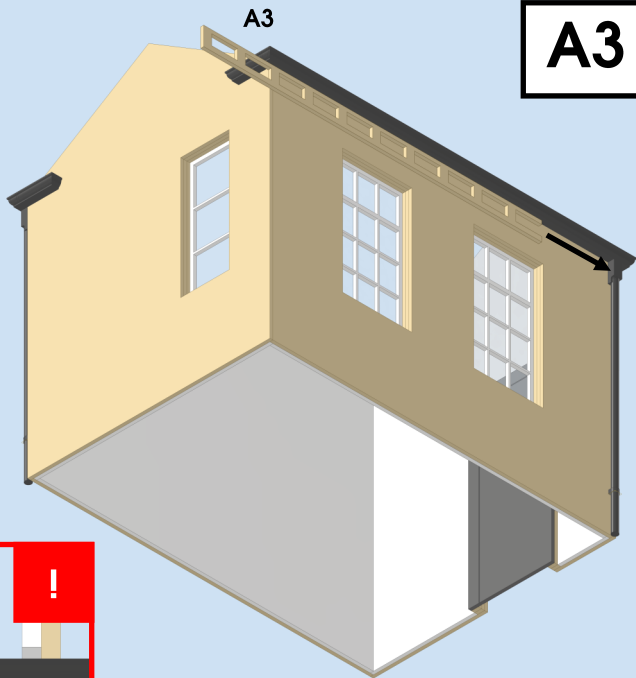

18

A4

A4

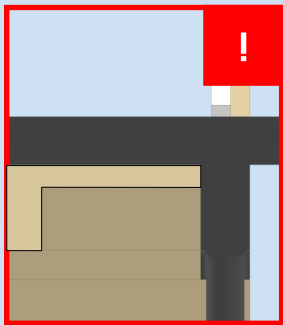
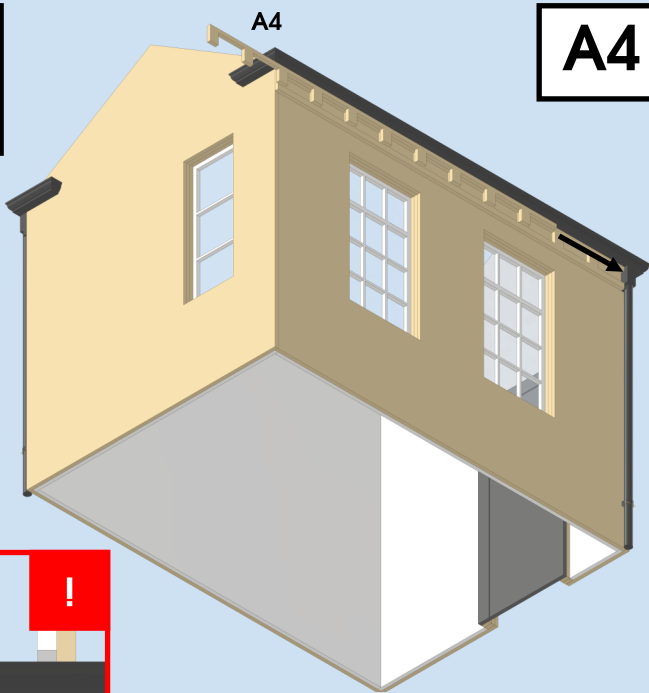

19

C3

C3

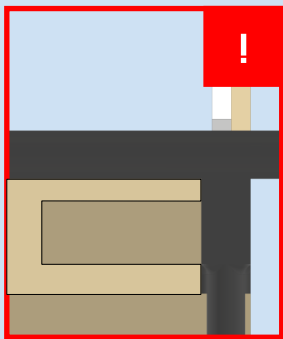
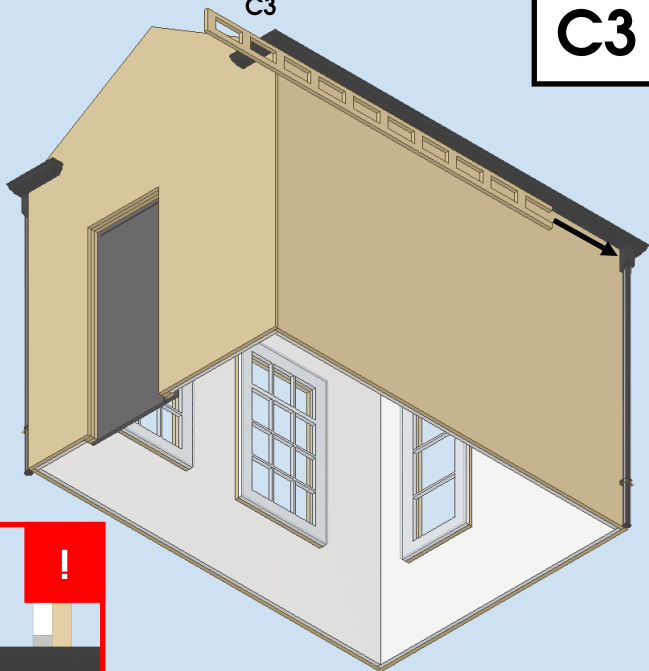

20

C4

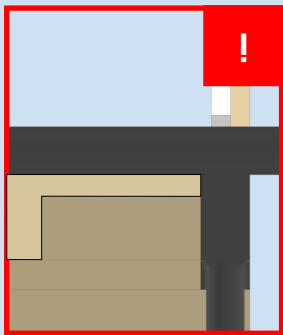
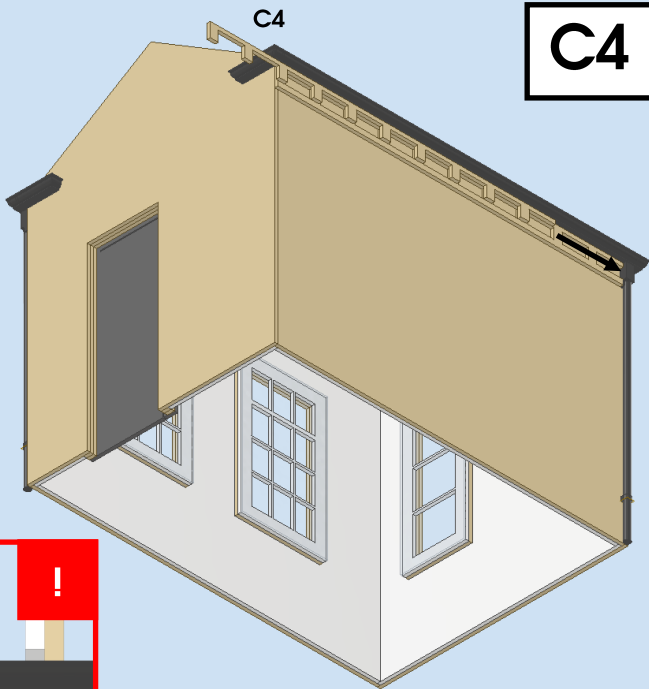

21

B3(x2)

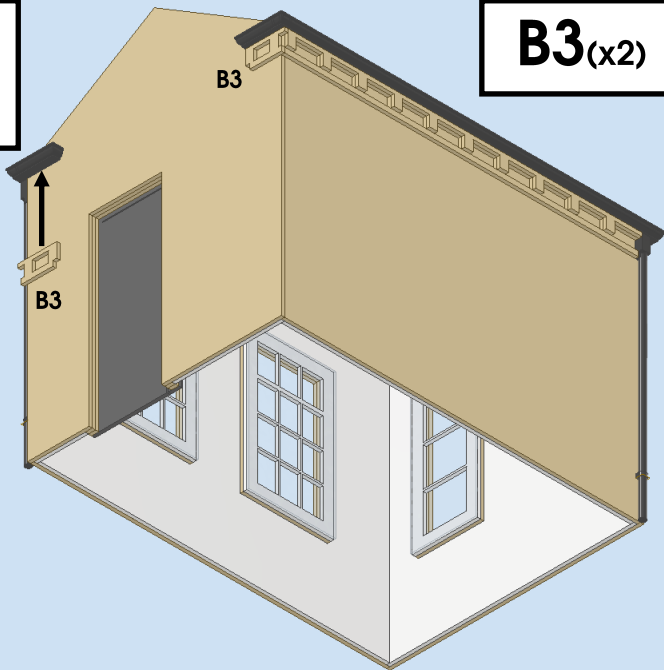

!

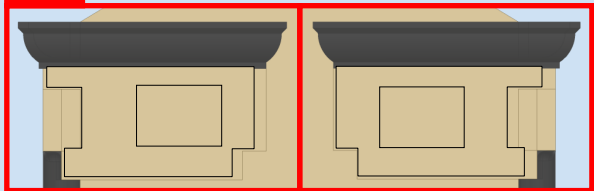

22

B4(x2)

B4

B4

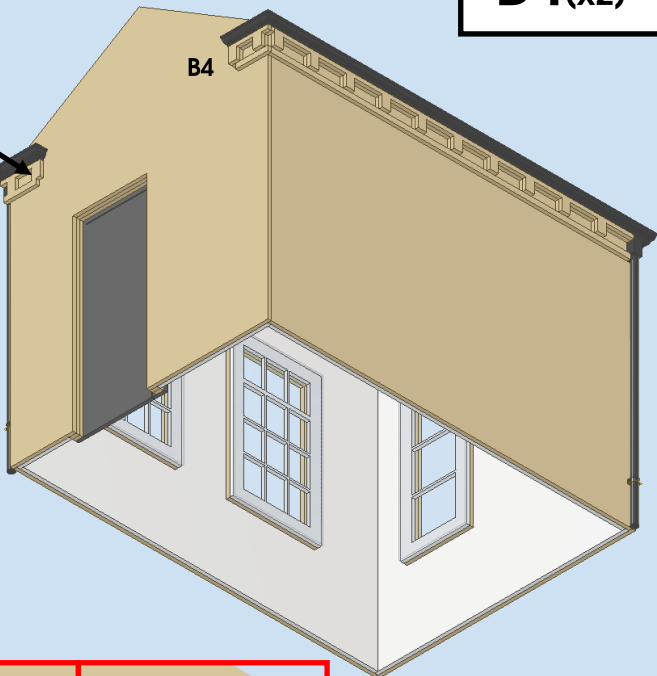
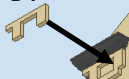

!

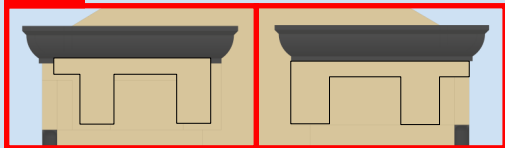

23

D3(x2)

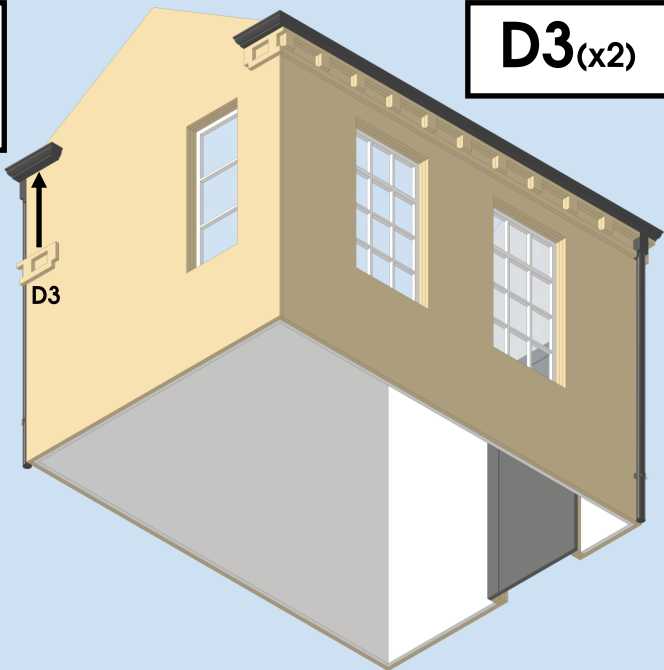

!

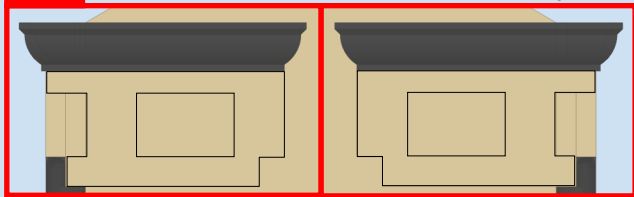

24

D4(x2)

D4

D4

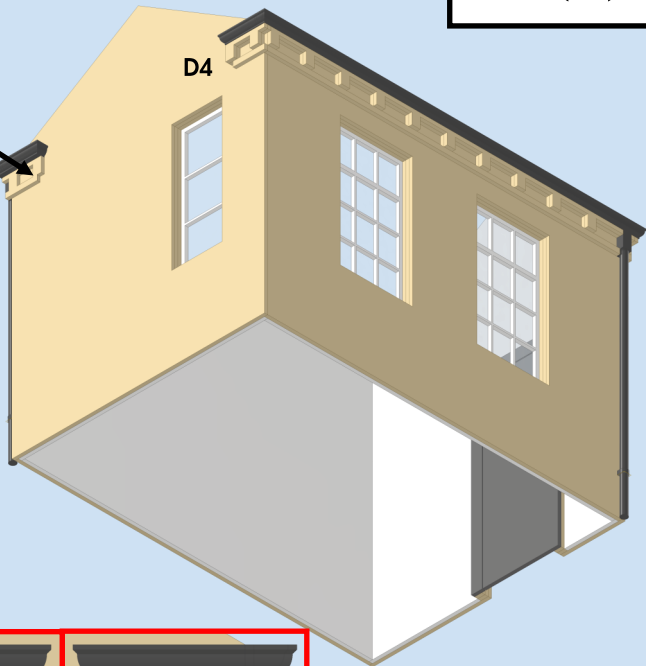
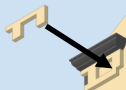

!

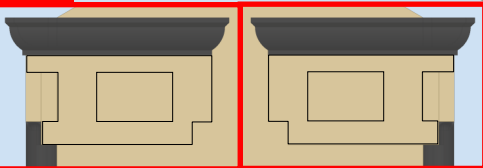

25

A5(x2)

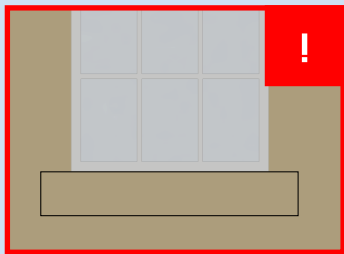
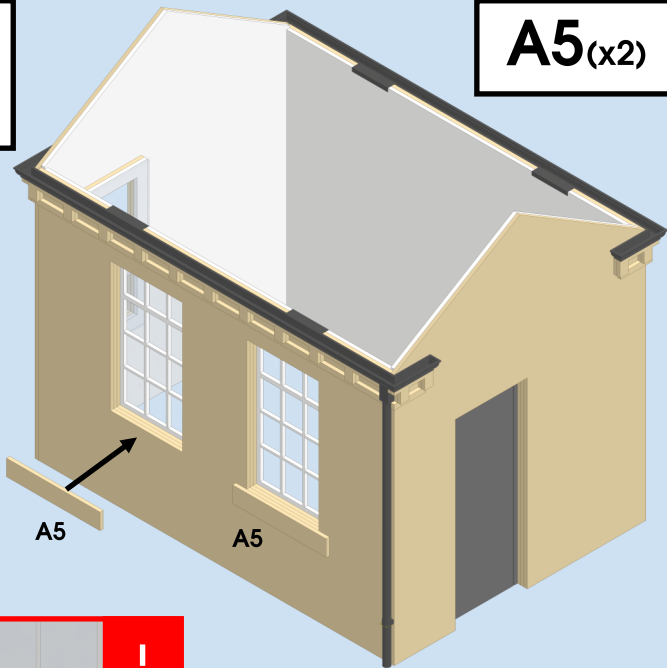

26

D7

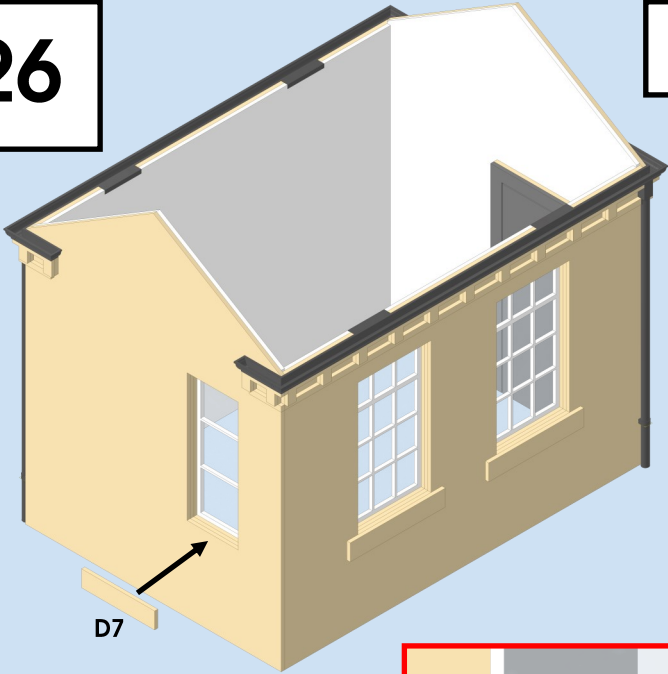

D7

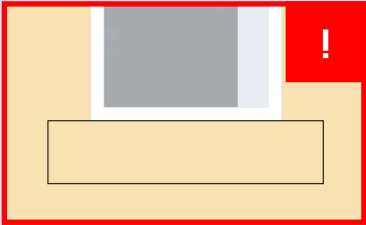

27

F1

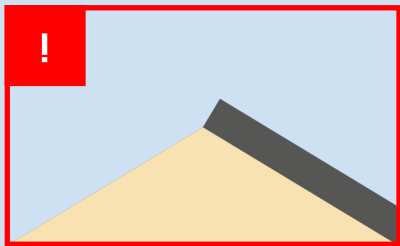
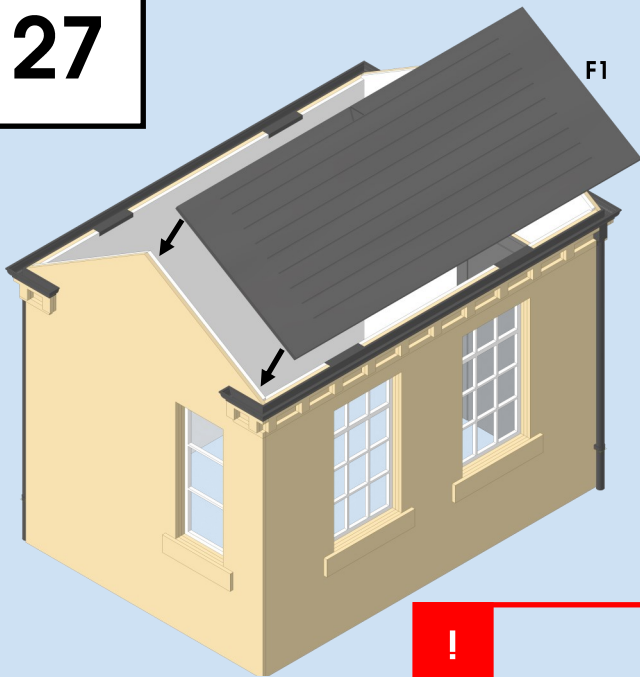

28

F1

D7

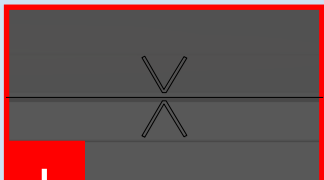
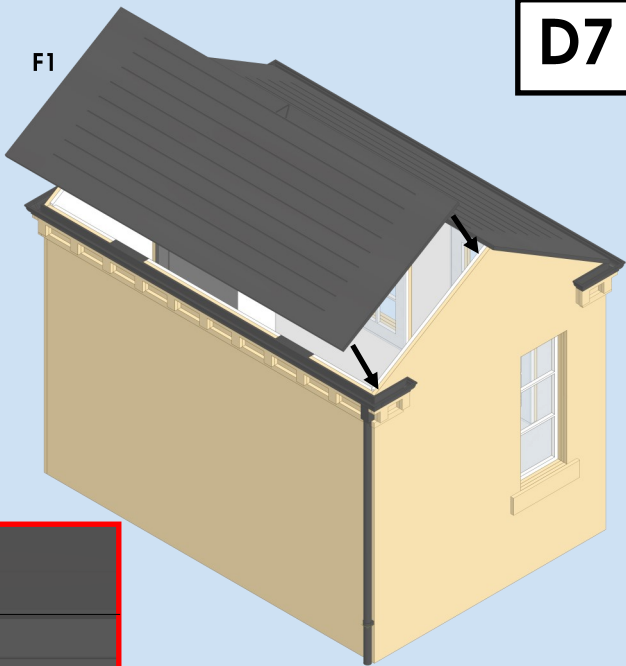

!

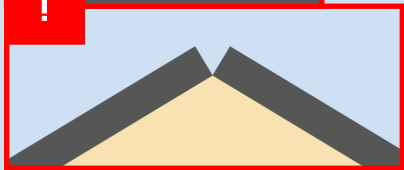

29

F8(x2)

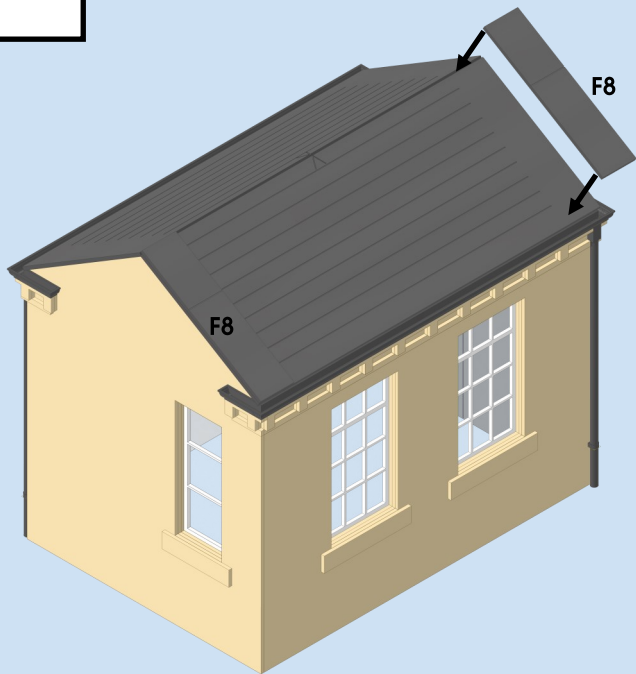

30

F8(x2)

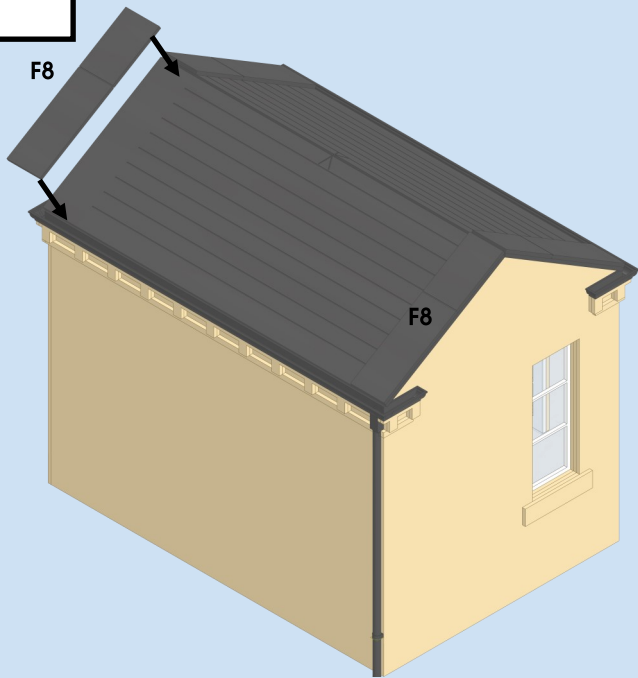

31

F9

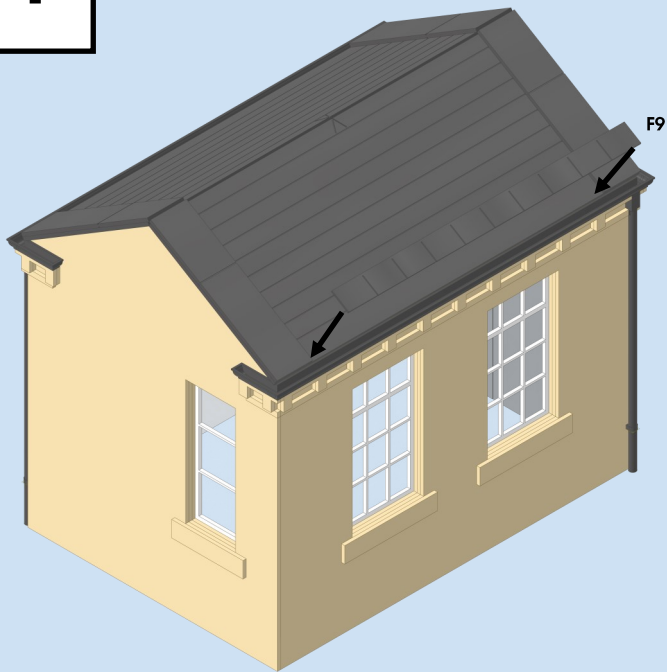

32

F10

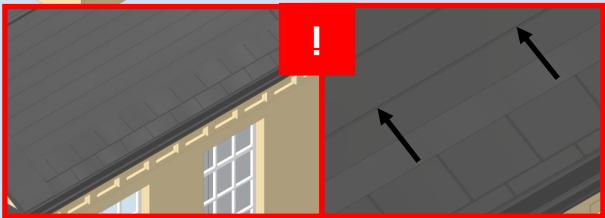
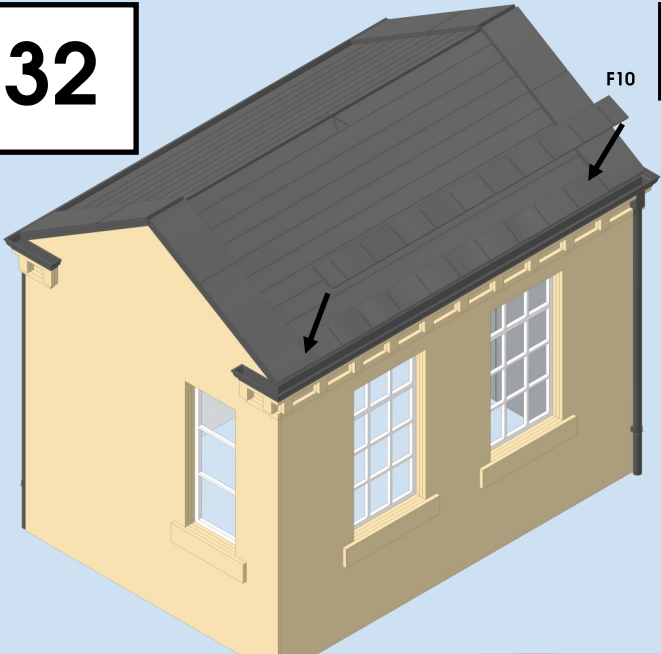

33

F11

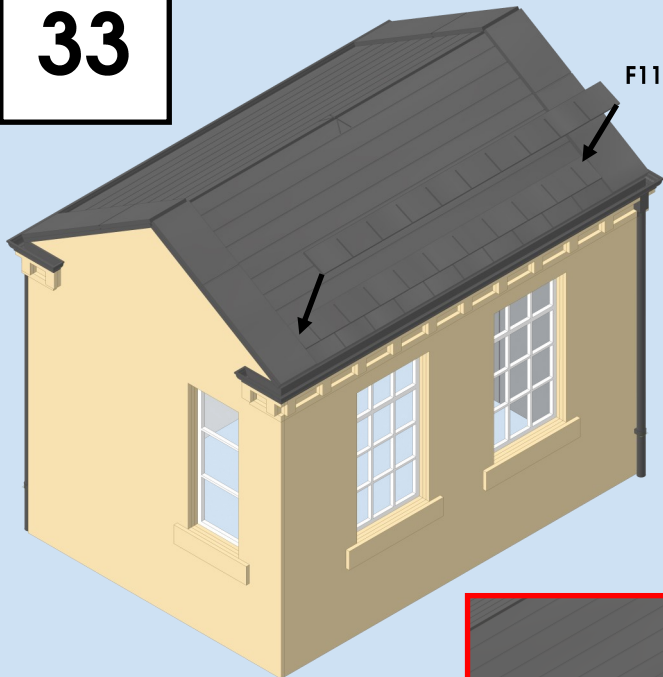

34

F10(x3) & F11(x3)

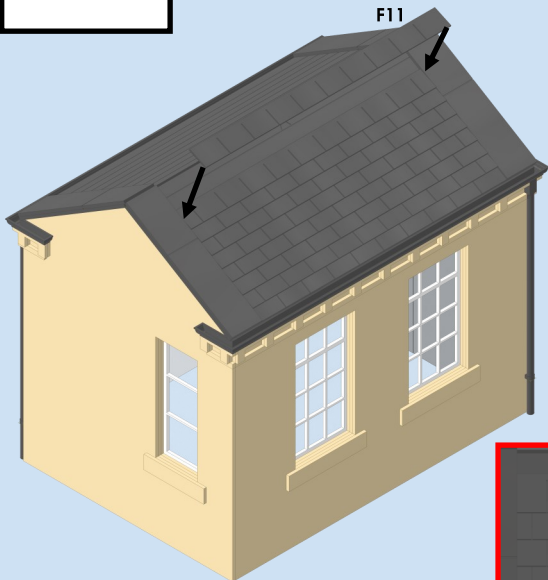

35

F9

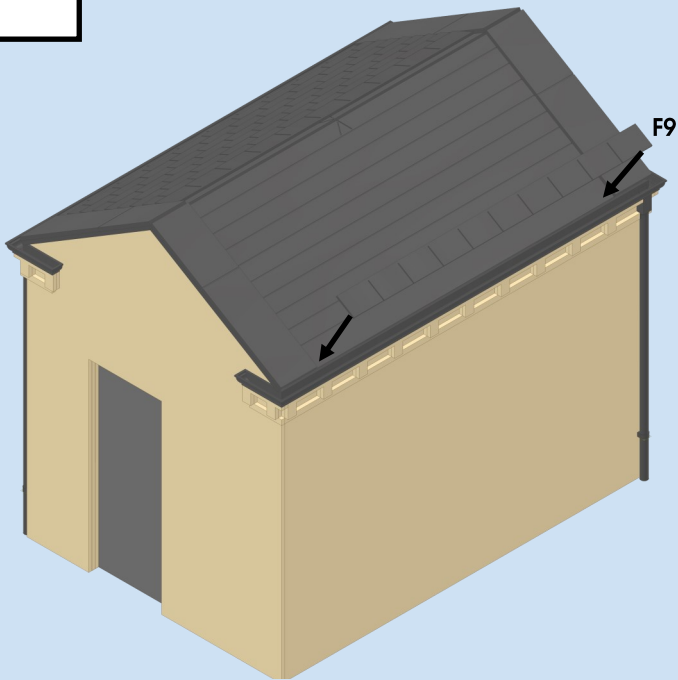

36

F12, F13 & F14

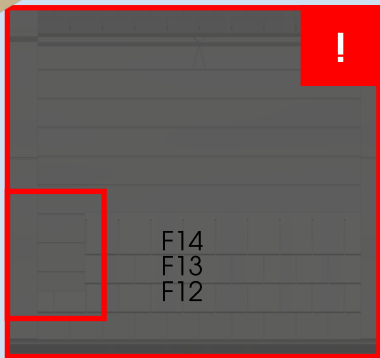
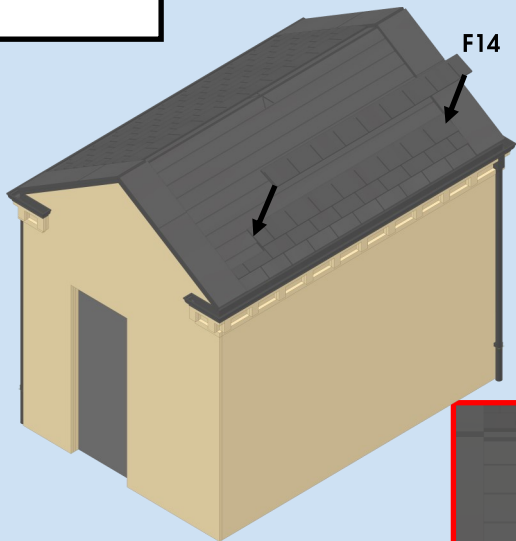

37

F2 & F5

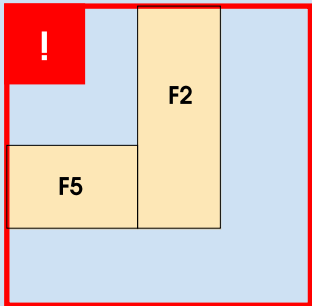
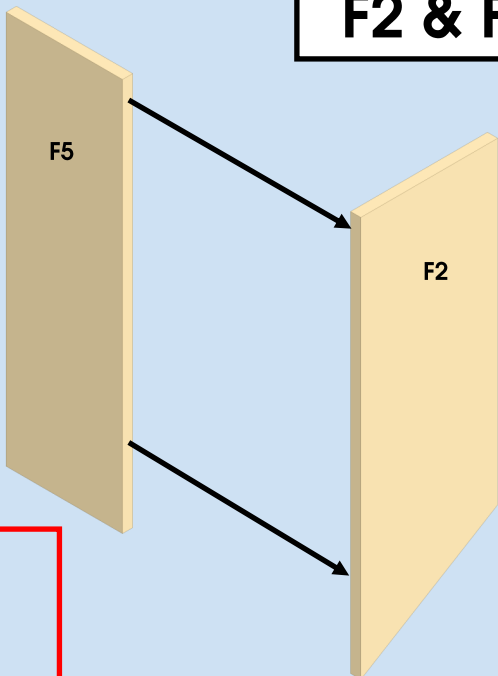

38

F & F4

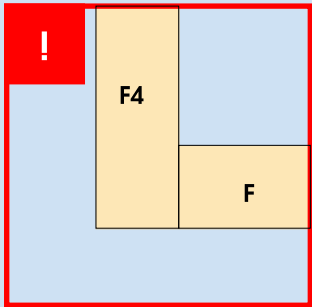
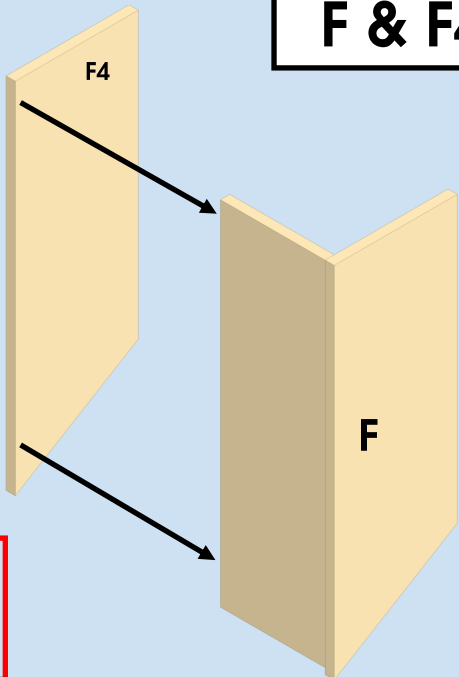

39

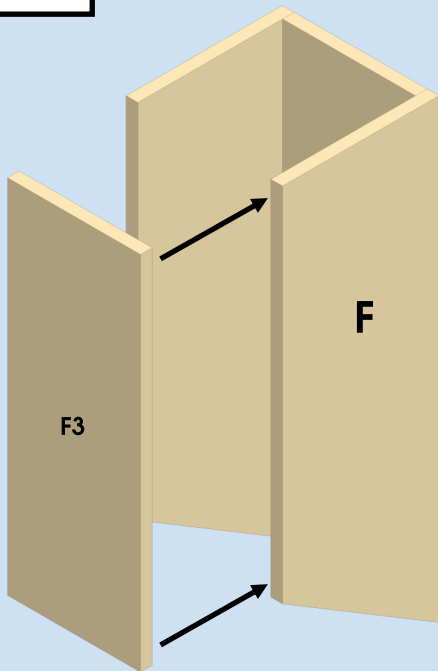

F & F3

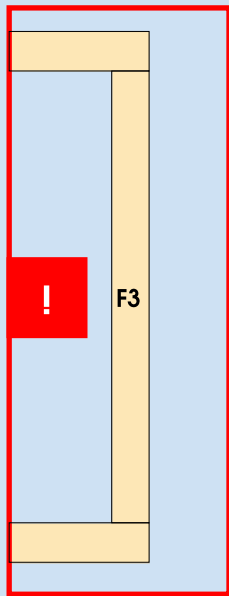

40

F & F6

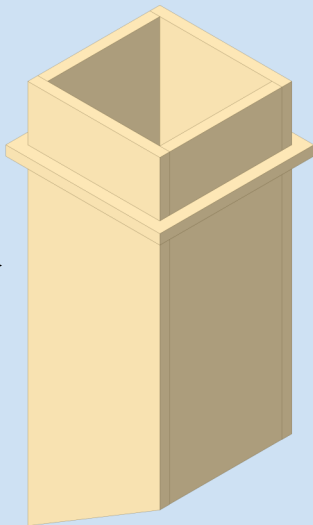
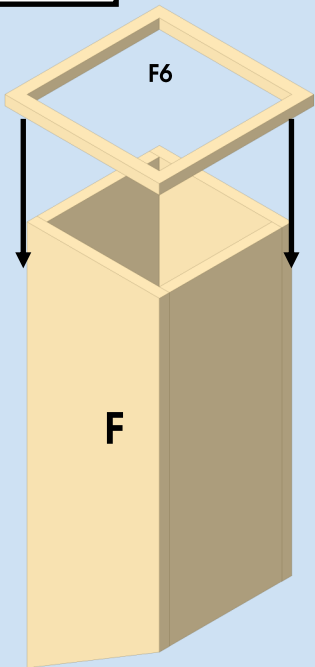

41

F & F7

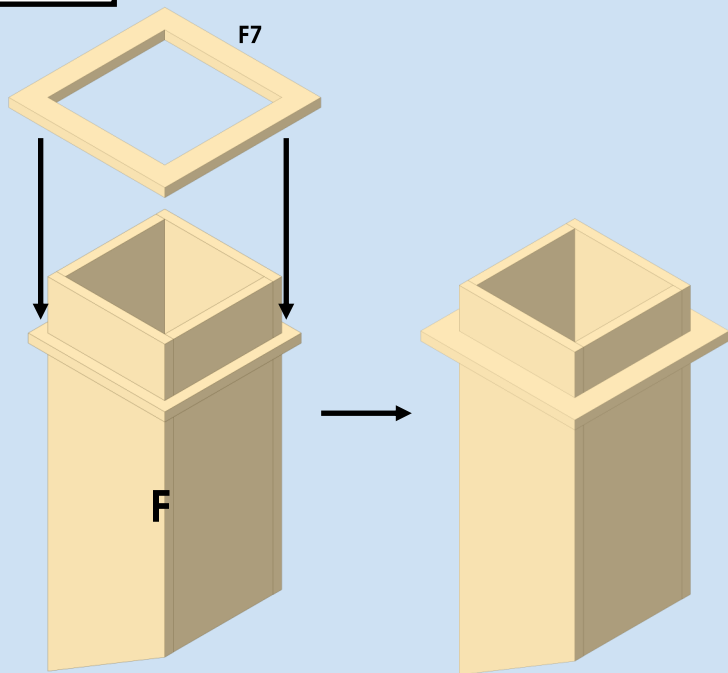

42

F

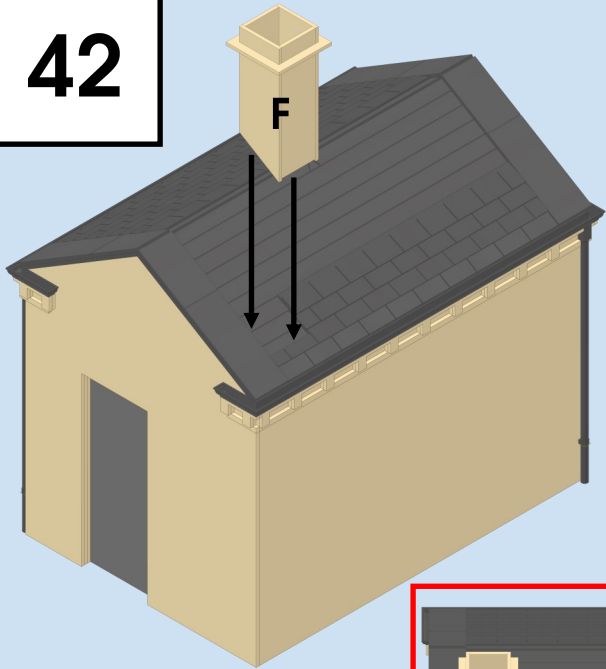

!



43

F15

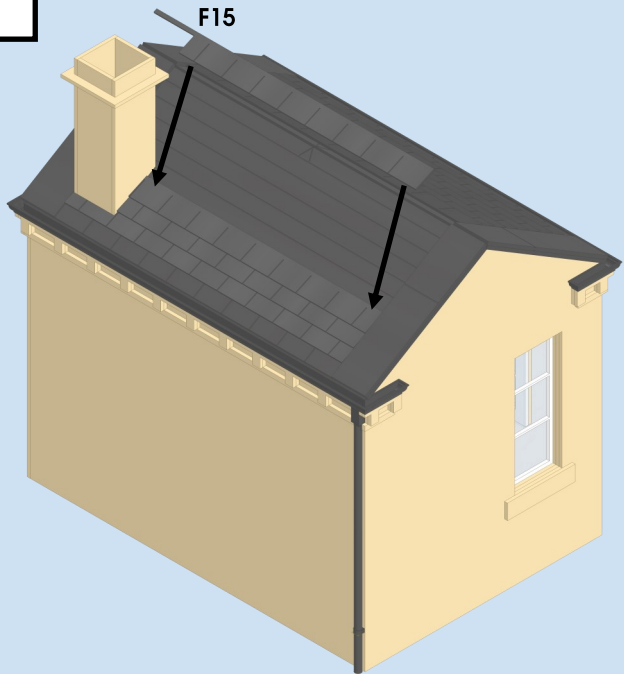

44

F16

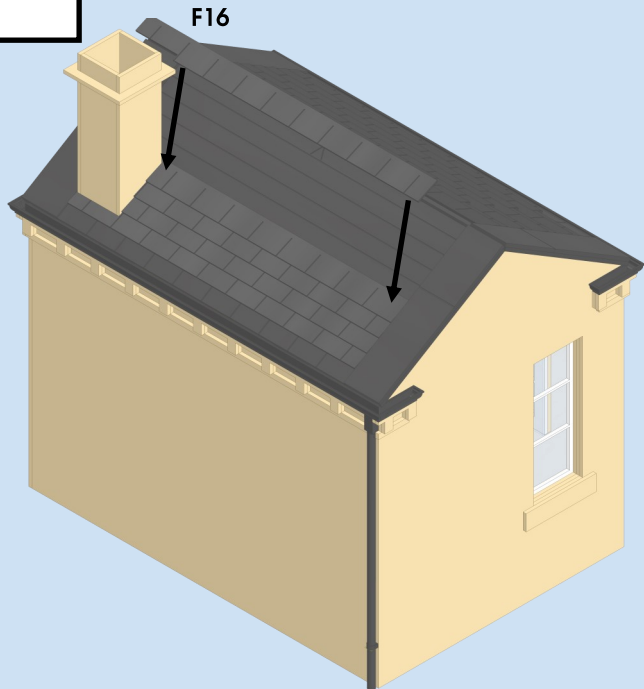

45

F10_(x1) & F11_(x2)

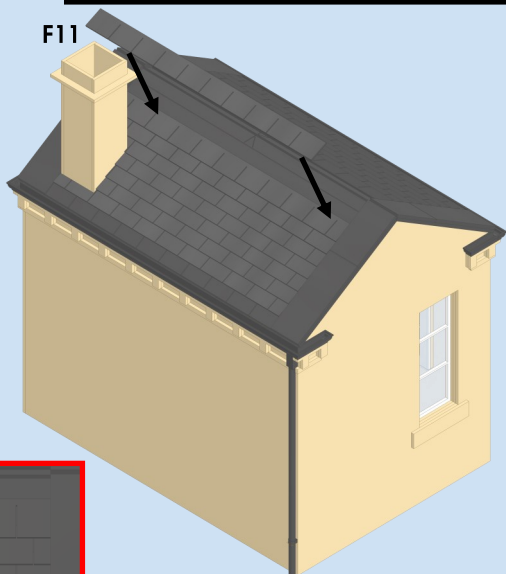

F11



F11
F10
F11
F16
F15
F14
F13
F12
F9

46

F17

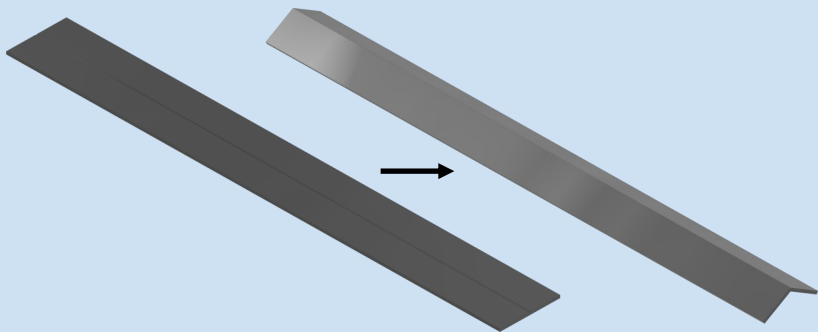

47

F17

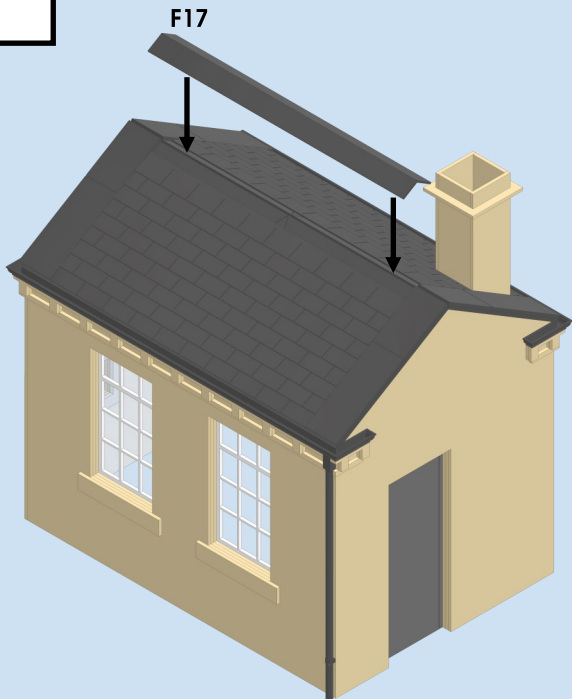

48



The logo for 'dapol' is centered on a blue background. The word 'dapol' is written in a lowercase, italicized, sans-serif font. It is enclosed within a thin, light gray rectangular border that follows the slant of the letters. The background is a solid blue color, with a white curved line separating it from a gray area on the left side of the image.

dapol